

ezpeleta<sup>®</sup>

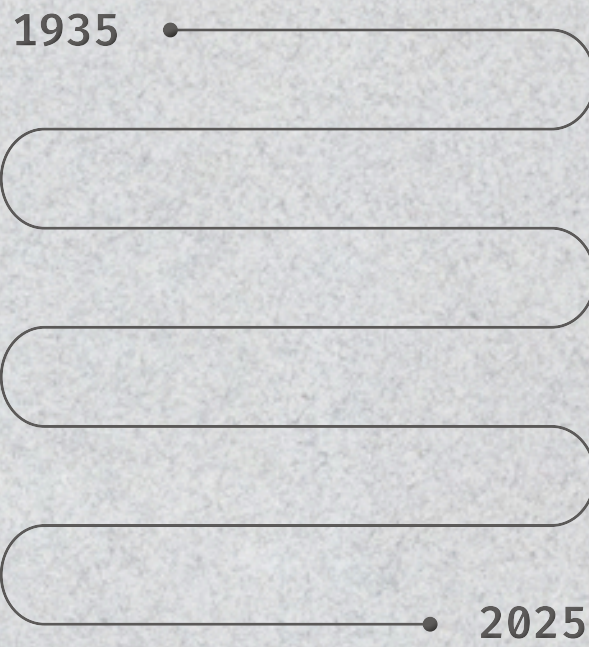



ezpeleta







**90 AÑOS DE HISTORIA** *de familia, innovación y dedicación*  
**90 ANOS DE HISTÓRIA** *de família, inovação e dedicação*  
**90 YEARS OF HISTORY** *of family, innovation and devotion*  
**90 ANS D'HISTOIRE** *de famille, d'innovation et de dévouement*

1935

Oñati

**ES.** Hemos recorrido un largo camino desde nuestros inicios en 1935, cuando comenzamos la fabricación artesanal de paraguas en Oñati, hasta convertirnos en una referencia en mobiliario de exterior. A lo largo de estas nueve décadas, nuestra pasión por el diseño y la calidad nos ha llevado a evolucionar continuamente, adaptándonos a las necesidades de nuestros clientes.

En 1952, dimos un paso importante al establecer nuestras instalaciones en Vigo, donde continuamos con la fabricación de paraguas. Fue aquí donde también empezamos a desarrollar nuestros primeros parasoles y muebles de jardín, hasta llegar a lo que somos hoy: una empresa especializada en crear espacios exteriores integrales, con una gama completa de productos que abarca desde sillas y mesas, hasta tumbonas, separadores y parasoles.

**PT.** Percorremos um longo caminho desde o nosso início em 1935, quando começámos a fabricar guarda-chuvas artesanais em Oñati, até nos tornarmos uma referência no mobiliário de exterior. Ao longo destas nove décadas, a nossa paixão pelo design e pela qualidade levou-nos a evoluir continuamente, adaptando-nos às necessidades dos nossos clientes.

Em 1952, demos um importante passo em frente ao estabelecer as nossas instalações em Vigo, onde continuámos a fabricar guarda-chuvas. Foi também aqui que começámos a desenvolver os primeiros guarda-sóis e mobiliário de jardim, até nos tornarmos no que somos hoje: uma empresa especializada na criação de espaços exteriores integrais, com uma gama completa de produtos, desde cadeiras e mesas a espreguiçadeiras, divisórias e guarda-sóis.



1952

Second generation of the family

1972  
We started manufacturing parasols



1966

Handmade umbrella manufacturing

**FR.** Nous avons parcouru un long chemin depuis nos débuts en 1935, lorsque nous avons commencé à fabriquer des parapluies à la main à Oñati, jusqu'à devenir une référence en matière de mobilier d'extérieur. Tout au long de ces neuf décennies, notre passion pour le design et la qualité nous a conduit à évoluer en permanence, en nous adaptant aux besoins de nos clients.

En 1952, nous avons franchi une étape importante en établissant nos installations à Vigo, où nous avons continué à fabriquer des parapluies. C'est là que nous avons également commencé à développer nos premiers parasols et meubles de jardin, jusqu'à devenir ce que nous sommes aujourd'hui : une entreprise spécialisée dans la création d'espaces extérieurs intégraux, avec une gamme complète de produits allant des chaises, tables aux chaises longues, en passant par les cloisons et les parasols.

1974  
New factory in Vigo



Manufacturing garden furniture

**UNA GRAN FAMILIA** *nuestra mayor fortaleza*  
**UMA GRANDE FAMÍLIA** *a nossa maior força*  
**A BIG FAMILY** *our greatest strength*  
**UNE GRANDE FAMILLE** *notre plus grande force*

**ES.** Somos una empresa 100% familiar, actualmente liderada por la tercera generación de la familia Ezpeleta. Sin embargo, no estaríamos aquí sin el esfuerzo y la dedicación de nuestro equipo, muchos de los cuales llevan con nosotros décadas, formando una verdadera familia. Gracias a este espíritu de compromiso y lealtad, hemos podido seguir creciendo y ofreciendo productos de la más alta calidad.

**PT.** Somos uma empresa 100% familiar, atualmente liderada pela terceira geração da família Ezpeleta. No entanto, não estaríamos aqui sem o esforço e a dedicação da nossa equipa, muitos dos quais estão conosco há décadas, formando uma verdadeira família. Graças a este espírito de compromisso e lealdade, conseguimos continuar a crescer e a oferecer produtos da mais alta qualidade.

**EN.** We are a 100% family-run business, currently led by the third generation of the Ezpeleta family. However, we would simply not have been standing here without the effort and commitment of our team, many of whom have been with us for decades, forming a real family. Thanks to this committed and loyal spirit, we have grown and continue to offer the highest-quality products.

**FR.** Nous sommes une entreprise 100% familiale, actuellement dirigée par la troisième génération de la famille Ezpeleta. Cependant, nous ne serions pas là sans l'effort et le dévouement de notre équipe, dont beaucoup travaillent avec nous depuis des décennies, formant ainsi une véritable famille. C'est grâce à cet esprit d'engagement et de loyauté que nous avons pu continuer à nous développer et à offrir des produits de la plus haute qualité.

1988

Vila Nova de Cerveira.  
Third generation of the family



1989

First trip to China



1990

First advertising sales



1992

+2000 parasols/day



2006

Ezpeleta América  
(México)

2010

Portugal,  
new operations  
head quarters



**EZPELETA SIN FRONTERAS** *más de 90 países*

**EZPELETA SEM FRONTEIRAS** *mais de 90 países*

**EZPELETA WITHOUT BORDERS** *more than 90 countries*

**EZPELETA SANS FRONTIÈRES** *plus de 90 pays*

**ES.** Nuestro crecimiento y expansión han sido posibles gracias a la confianza y lealtad de nuestros clientes, que nos han acompañado en cada paso de nuestra evolución. Sus preferencias y necesidades nos han impulsado a cruzar fronteras y ofrecer nuestros productos en más de 90 países, consolidándonos en mercados diversos y exigentes. Seguimos innovando y mejorando para cumplir con las expectativas de nuestros clientes globales, ofreciendo mobiliario exterior que destaca por su calidad, diseño y funcionalidad.

**PT.** O nosso crescimento e expansão foram possíveis graças à confiança e fidelidade dos nossos clientes, que nos acompanharam em cada passo da nossa evolução. As suas preferências e necessidades levaram-nos a atravessar fronteiras e a oferecer os nossos produtos em mais de 90 países, consolidando a nossa posição em mercados diversos e exigentes. Continuamos a inovar e a melhorar para satisfazer as expectativas dos nossos clientes globais, oferecendo mobiliário de exterior que se destaca pela sua qualidade, design e funcionalidade.

**EN.** Our growth and expansion have been possible thanks to our customers' trust and loyalty, as they have accompanied us in every step of our journey. Their preferences and needs have driven us to cross borders and offer our products in more than 90 countries, consolidating our position in diverse and demanding markets. We strive to constantly innovate and improve to meet our global customers' expectations, offering outdoor furniture that stands out for its quality, design, and functionality.

**FR.** Notre croissance et notre expansion ont été possibles grâce à la confiance et à la fidélité de nos clients, qui nous ont accompagnés à chaque étape de notre évolution. Leurs préférences et leurs besoins nous ont poussés à franchir les frontières et à proposer nos produits dans plus de 90 pays, consolidant ainsi notre position sur des marchés divers et exigeants. Nous continuons à innover et à nous améliorer pour répondre aux attentes de nos clients du monde entier, en proposant des meubles d'extérieur qui se distinguent par leurs qualités, leurs designs et leurs fonctionnalités.





2014

We started manufacturing gas-assisted injected furniture



2020

EOLO PURETI, first air purifying parasol



2015

ONE TABLE by Aitor García de Vicuña



2022

LAGO SUN LOUNGER receives a prestigious award



2023

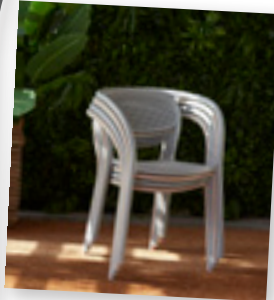

NOON ARMCHAIR by Héctor Serrano



TRENA COLLECTION by Yonoh Studio



2025

We operate in more than 90 countries



2024

Tribute to the team and the second generation of the family

INNOVACIÓN Y SOSTENIBILIDAD *siempre de la mano*

INOVAÇÃO E SUSTENTABILIDADE *sempre de mãos dadas*

INNOVATION AND SUSTAINABILITY *always go hand in hand*

INNOVATION ET DURABILITÉ *toujours main dans la main*

**ES.** Estamos enfocados en crear soluciones sostenibles, empleando materiales y procesos que respeten el medio ambiente, sin comprometer el diseño y la funcionalidad de nuestros productos.

La mayor parte de nuestros productos están 100% fabricados en Portugal por un equipo de profesionales locales, en colaboración con proveedores de cercanía y utilizando materiales 100% reciclados y reciclables. Además, ofrecemos repuestos para extender la vida útil de nuestros productos, apostando por un enfoque sostenible de principio a fin y promoviendo la durabilidad y funcionalidad como valores fundamentales.

En Ezpeleta, cada producto que fabricamos está pensado para crear espacios acogedores y únicos, que reflejan tanto nuestra experiencia como nuestra pasión por el detalle.

**PT.** Estamos focados em criar soluções sustentáveis, utilizando materiais e processos amigos do ambiente, sem comprometer o design e a funcionalidade dos nossos produtos.

A maioria dos nossos produtos é 100% fabricada em Portugal por uma equipa de profissionais locais, em colaboração com fornecedores locais e utilizando materiais 100% reciclados e recicláveis. Além disso, oferecemos peças de substituição para prolongar a vida útil dos nossos produtos, apostando numa abordagem sustentável do princípio ao fim e promovendo a durabilidade e a funcionalidade como valores fundamentais.

Na Ezpeleta, cada produto que fabricamos é concebido para criar espaços acolhedores e únicos, reflectindo a nossa experiência e a nossa paixão pelo detalhe.

**EN.** We strive to create sustainable solutions using environmentally friendly materials and processes without compromising the design and functionality of our products.

Most of our products are 100% manufactured in Portugal by a local team of professionals, collaborating with local suppliers and using 100% recyclable materials. In addition, we offer spare parts to extend the useful life of our products, committed to a sustainable approach from start to finish and promoting durability and functionality as core values.

At Ezpeleta, every product we manufacture is designed to create welcoming and unique spaces, reflecting both our experience and our passion for detail.

**FR.** Nous nous concentrons sur la création de solutions durables, en utilisant des matériaux et des processus respectueux de l'environnement, sans compromettre le design et la fonctionnalité de nos produits.

La plupart de nos produits sont fabriqués à 100% au Portugal par une équipe de professionnels locaux, en collaboration avec des fournisseurs locaux et en utilisant des matériaux 100% recyclés et recyclables. En outre, nous proposons des pièces de rechange pour prolonger la durée de vie utile de nos produits, en nous engageant à adopter une approche durable du début à la fin et en faisant de la durabilité et de la fonctionnalité des valeurs fondamentales.

Chez Ezpeleta, chaque produit que nous fabriquons est conçu pour créer des espaces accueillants et uniques, reflétant à la fois notre expérience et notre passion du détail.





**12**

*Sillas, Cadeiras, Chairs, Chaises*

**64**

*Mesas, Tables*

**86**

*Lounge*

**106**

*Separadores, Space dividers, Séparateurs*

**112**

*Parasoles, Guarda-sóis, Parasols*

**135**

*Detalles técnicos, Detalhes técnicos, Technical details, Détails techniques*

**188**

*Bases*



# SILLAS

*Cadeiras*  
*Chairs*  
*Chaises*

**LUCY**

*34 years in Ezpeleta*

**ES.** La calidad de nuestros productos es el reflejo del saber hacer y la dedicación de un gran equipo multidisciplinar que trabaja con esmero para crear sillas que combinan diseño actual, resistencia y ligereza. Desde la óptima formulación de la materia prima hasta, finalmente, la revisión manual de cada pieza, asegurando un acabado de calidad.

En 2014 desarrollamos nuestro primer molde de inyección por gas de sillas de polipropileno reforzado con fibra de vidrio. Hoy se han convertido en una de nuestras principales gamas de producto, siendo la opción elegida para amueblar espacios outdoor alrededor de todo el mundo.

**EN.** Our products' quality reflects the know-how and devotion of a multidisciplinary team, all working tirelessly to create chairs that combine modern design, strength, and a lightweight feel. Starting with the ideal formulation of the raw material and, finally, the manual inspection of each piece, ensuring a quality finish.

In 2014, we developed our first gas injection mould for glass fibre-reinforced polypropylene chairs. These have become one of our core product ranges, proving a popular choice for furnishing outdoor spaces worldwide.

**PT.** A qualidade dos nossos produtos é o reflexo do saber-fazer e da dedicação de uma vasta equipa multidisciplinar que trabalha com cuidado para criar cadeiras que combinem design moderno, resistência e leveza. Desde a formulação otimizada da matéria-prima até, finalmente, à revisão manual de cada peça, garantindo um acabamento de qualidade.

Em 2014, desenvolvemos o nosso primeiro molde de injeção a gás para cadeiras em polipropileno reforçado com fibra de vidro. Atualmente, estas são uma das nossas principais gamas de produtos, sendo a escolha de eleição para mobilar espaços exteriores em todo o mundo.

**FR.** La qualité de nos produits est le reflet du savoir-faire et du dévouement d'une grande équipe multidisciplinaire qui travaille avec soin pour créer des chaises qui allient design moderne, solidité et légèreté. De la formulation optimale de la matière première à la révision manuelle de chaque pièce, nous garantissons une finition de qualité.

En 2014, nous avons développé notre premier moule d'injection de gaz pour des chaises en polypropylène renforcé de fibres de verre. Aujourd'hui, elles sont devenues l'une de nos principales gammes de produits, et sont choisies pour meubler les espaces extérieurs dans le monde entier.





# TRENA

by Yonoh Studio

Premis  
ADCV  
2024  
Plata

if  
DESIGN  
AWARD  
2024







TRENA STOOL - blue grey, taupe  
URBAN - taupe-dark oak



TRENA CHAIR - soft pink



TRENA CHAIR - blue grey, pearl





**TRENA CHAIR** - blue grey, pearl

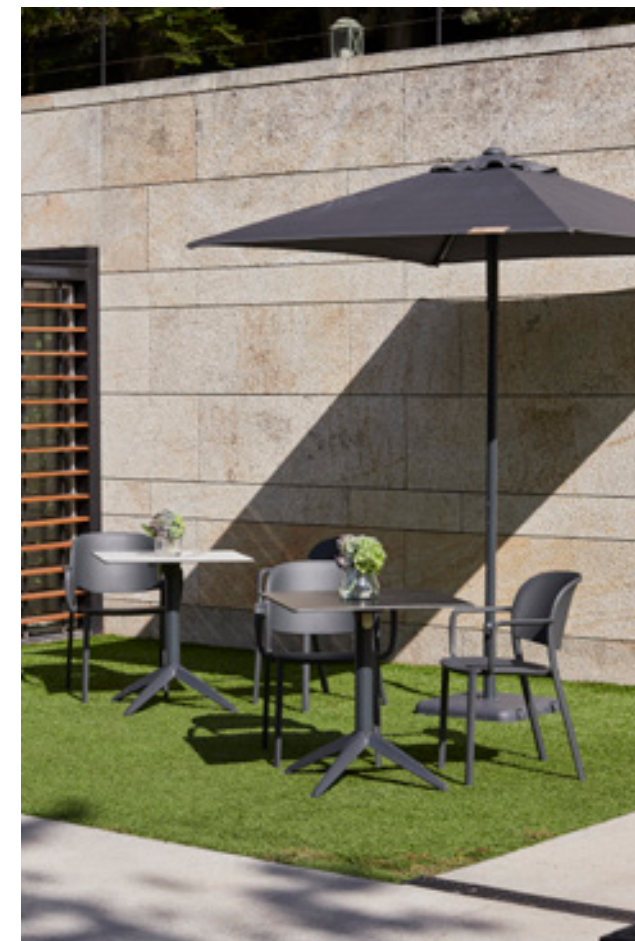

**TRENA ARMCHAIR** - anthracite  
**QUATRO FOLD** - anthracite-black marble, anthracite-white marble  
**EOLO PURETTI** - anthracite-anthracite  
**BOND** - anthracite



**TRENA ARMCHAIR** - terracota  
**TRENA STOOL** - pearl  
**MEET** - taupe-oak



**TRENA STOOL** - blue grey  
**TRENA ARMCHAIR** - blue grey  
**URBAN** - anthracite-oak  
**MEET** - anthracite-oak



# NOON

*by Héctor Serrano*







NOON - taupe  
VILA - taupe

NOON - terracota  
MONACO - taupe-oak



NOON - blue grey



# BAKE WOOD







**BAKE WOOD PAD** - sand-pad taupe  
**QUATRO FOLD** - sand-taupe



**BAKE WOOD PAD** - olivo-pad taupe  
**QUATRO FIX** - anthracite-white marble



**BAKE WOOD** - taupe



**BAKE WOOD** - anthracite  
**QUATRO FIX** - anthracite-white marble



# BAKE







**BAKE** - taupe-terracota  
**QUATRO** - taupe-oak



**BAKE** - sand-taupe  
**QUATRO** - sand-taupe  
**FORMENTERA** - anthracite-taupe  
**KITCROSS** - anthracite



**BAKE** - anthracite-blue grey



**BAKE** - olivo-pearl  
**MONACO** - taupe-dark oak



# ROD







RODPAD - taupe-terracota-pad taupe



RODPAD - antracita-antracita-pad grey  
VILA - antracite





# HOP







**HOP** - taupe, terracota  
**QUATRODUO** - sand-taupe  
**NEW TOSCANA** - sand  
**BOND** - white

**HOP** - white  
**KOS** - white-white





# FADO







**FADO** - aquamarine, taupe, sand  
**MEET** - taupe - dark oak



**FADO** - olivo



**FADO** - olivo, mustard  
**QUATRO DUO** - sand-oak  
**EOLO PURETI** - taupe-sand  
**BOND** - taupe



# ATTIC

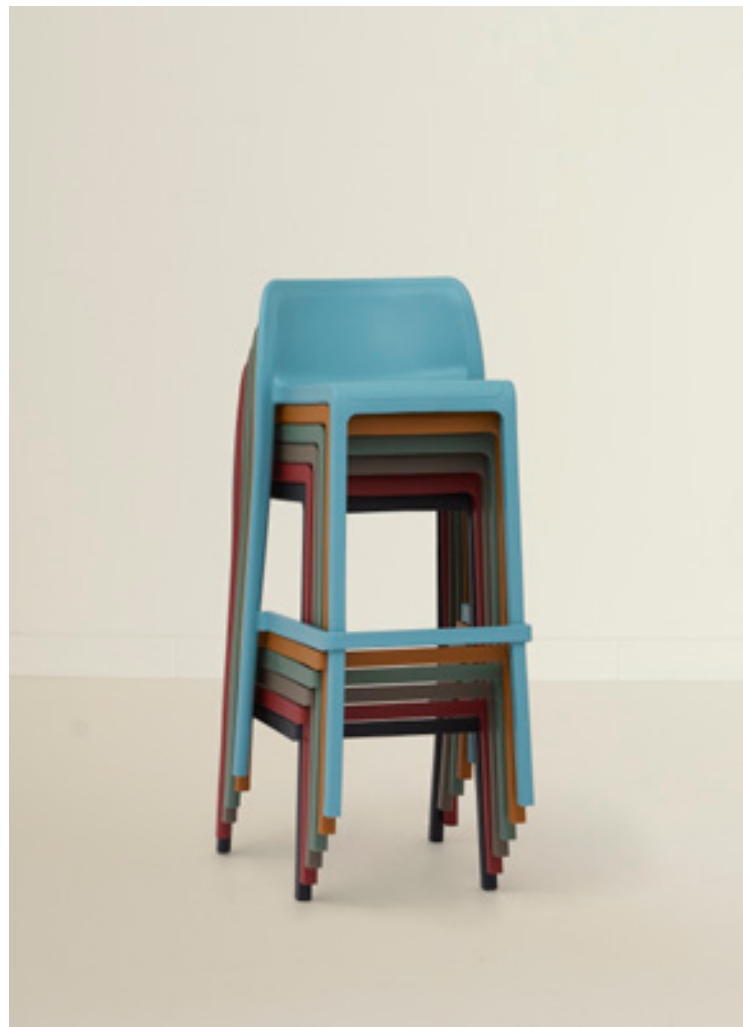





ATTIC - mustard



ATTIC - sand, olivo  
URBAN - anthracite-dark oak

ATTIC - aquamarine

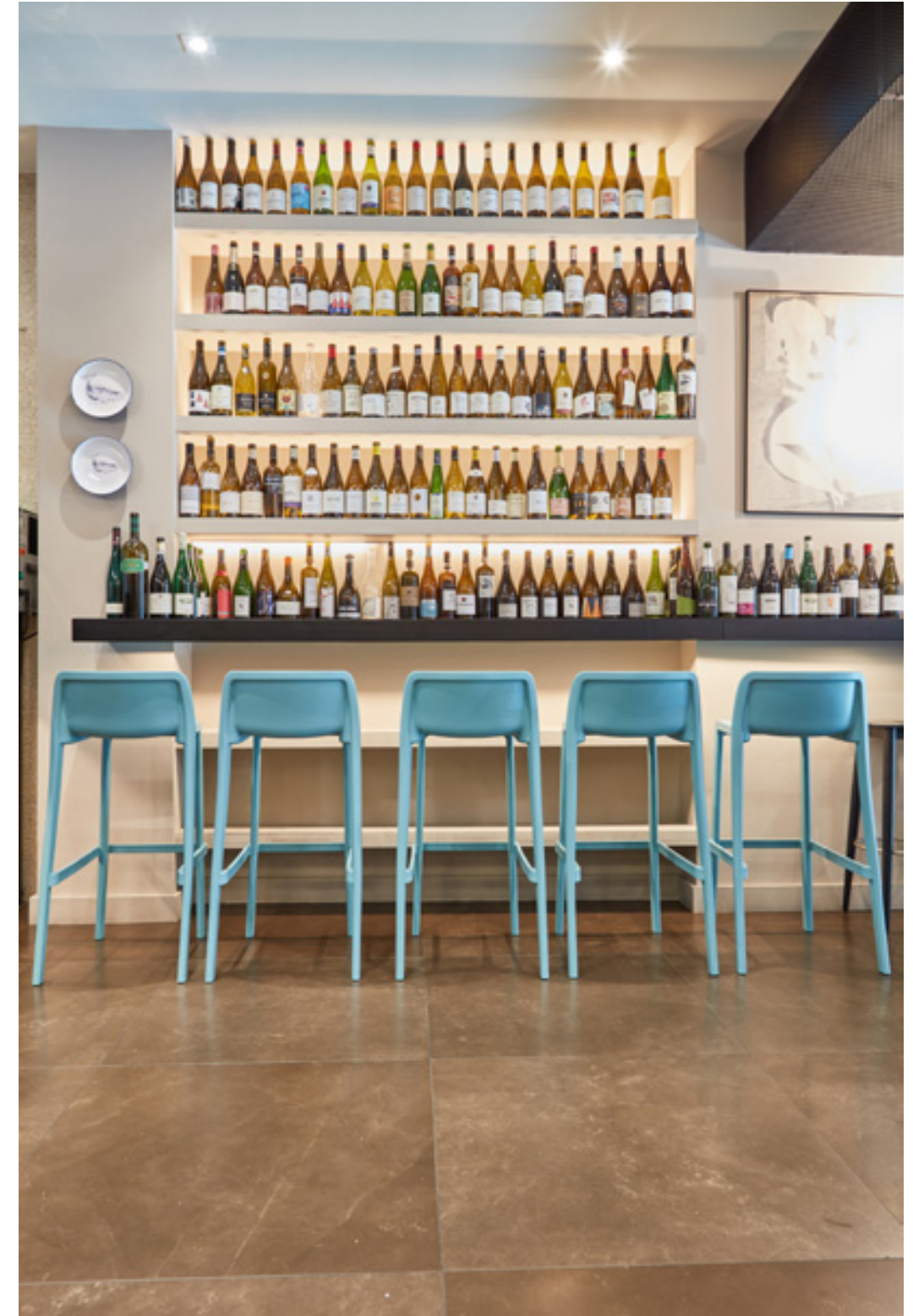





# TOWN







**TOWN** - mustard  
**MEET** - anthracite-anthracite



**TOWN** - brick, olivo  
**MONACO** - sand-oak



**TOWNPAD** - white-pad taupe, taupe-pad taupe  
**MEET** - taupe-oak



# PARK







**PARK** - ocean  
**MEET** - taupe-oak



**PARK** - taupe, ocean



**PARK** - white  
**KOS** - white - oak



# DOCK







**DOCK** - taupe  
**MEET** - anthracite-taupe  
**RIO** - white-white



**DOCK** - white  
**KOS** - white-oak



# LAND







**LAND** - white  
**PALMA** - white-white  
**QUATRO FIX** - white-white  
**VILA** - white-white



**LAND** - anthracite  
**QUATRO** - anthracite-white marble  
**FORMENTERA LATERAL** - anthracite-anthracite  
**CANTO** - anthracite



# MESAS

*Tables*

**LUCAS**

*21 years in Ezpeleta*

**ES.** La clave detrás de nuestros 90 años de historia es, sin duda, el trabajo en equipo bien coordinado. Cada una de nuestras mesas es ensamblada por un grupo de personas que trabajan mano a mano para garantizar la calidad en cada fase del proceso, mediante procedimientos estandarizados que optimizan los recursos y, además, nos permiten reducir el impacto medioambiental.

El resultado son mesas funcionales y versátiles, compuestas de materiales ligeros, resistentes y 100% reciclables.

**EN.** Without a doubt, our 90-year history is based on well-coordinated teamwork. Each of our tables is assembled by a group of people who work hand in hand to ensure that each stage of the process is of the highest quality, using standardised procedures that optimise resources and also allow us to reduce our environmental impact.

As a result, our tables are functional and versatile, made of light, resistant and 100% recyclable materials.

**PT.** A chave dos nossos 90 anos de história é, sem dúvida, um trabalho de equipa bem coordenado. Cada uma das nossas mesas é montada por um grupo de pessoas que trabalham lado a lado para garantir a qualidade em todas as fases do processo, utilizando procedimentos estandarizados que optimizam os recursos e nos permitem também reduzir o nosso impacto ambiental.

O resultado são mesas funcionais e versáteis, feitas de materiais leves, resistentes e 100% recicláveis.

**FR.** La clé de nos 90 ans d'histoire est sans aucun doute un travail d'équipe bien coordonné. Chacune de nos tables est assemblée par un groupe de personnes qui travaillent main dans la main pour garantir la qualité à chaque étape du processus, en utilisant des procédures standardisées qui optimisent les ressources et nous permettent également de réduire notre impact sur l'environnement.

Il en résulte des tables fonctionnelles et polyvalentes, fabriquées avec des matériaux légers, résistants et 100 % recyclables.





# MEET





**MEET** - white-anthracite  
**TRENA ARMCHAIR** - anthracite, pearl  
**FORMENTERA** - anthracite-white  
**KITCROSS** - anthracite



**MEET** - taupe-taupe  
**FADO** - olivo  
**LAGO** - taupe-tweed olivo



**MEET** - taupe-oak  
**TRENA ARMCHAIR** - terracota  
**TRENA CHAIR** - pearl



# MONACO & URBAN







URBAN - taupe-oak  
TRENASTOOL - pearl



MONACO - taupe-taupe  
BAKE - sand-taupe



URBAN - taupe - dark oak  
TRENASTOOL - taupe  
MADEIRA - blue stripe  
CANTO - rust





**QUATRO**  
*fold, fix, high & duo*







QUATRO FOLD - sand-white  
BAKE - sand-taupe



QUATRO FOLD - taupe-oak  
BAKE - taupe-terracota



QUATRO HIGH FIX - taupe-oak  
ATTIC - aquamarine



# ONE







ONE - sand-oak  
FADO - sand, mustard



ONE - anthracite-stone  
TRENA ARMCHAIR - anthracite, pearl



ONE - taupe-taupe  
FADO - taupe, sand



# RODAS & KOS







**KOS** - white - oak  
**DOCK** - white



**RODAS** - white - white  
**FADO** - olivo  
**VIGO** - white



# LOUNGE

## MUNDO

*42 years in Ezpeleta*

**ES.** Nuestra larga trayectoria es fruto del gran compromiso que caracteriza a nuestro equipo. Son muchas las personas que han dedicado toda su vida profesional a esta empresa, entregando lo mejor de sí cada día.

En estos 90 años hemos ido sumando nuevas gamas de producto hasta convertirnos en fabricantes integrales de mobiliario outdoor. La línea lounge combina nuestras tres áreas de especialización: corte y confección textil, mecanizado de metal e inyección de polímeros, resultando en productos que priman el confort y la funcionalidad.

**EN.** Our lengthy track record is the result of the outstanding commitment that has distinguished our team. Many people have devoted their entire professional lives to this company, contributing their best every day.

Over these 90 years, we have been adding new product ranges until we have evolved into a comprehensive manufacturer of outdoor furniture. This lounge line combines our three fields of expertise: textile cutting and sewing, metal machining, and polymer injection, yielding products that prioritise comfort and functionality.

**PT.** A nossa longa história é o resultado do grande empenho que caracteriza a nossa equipa. Muitas pessoas dedicaram toda a sua vida profissional a esta empresa, dando o melhor de si todos os dias.

Nestes 90 anos, fomos acrescentando novas gamas de produtos até nos tornarmos um fabricante integral de mobiliário de exterior. A linha lounge combina as nossas três áreas de especialização: corte e costura de têxteis, maquinaria de metais e injeção de polímeros, resultando em produtos que privilegiam o conforto e a funcionalidade.

**FR.** Notre longue histoire est le résultat du grand engagement qui caractérise notre équipe. De nombreuses personnes ont consacré toute leur vie professionnelle à cette entreprise, donnant chaque jour le meilleur d'elles-mêmes.

Au cours de ces 90 années, nous avons ajouté de nouvelles gammes de produits pour devenir un fabricant intégral de mobilier d'extérieur. La ligne lounge combine nos trois domaines d'expertise: la coupe et la couture de textiles, l'usinage de métaux et l'injection de polymères, ce qui se traduit par des produits qui privilégient le confort et la fonctionnalité.





# LAGO







LAGO - white-white  
 VILA - white  
 EOLO - white-green stripe  
 BOND - white



LAGO - white-white, taupe-taupe  
 VILA - white, taupe  
 EOLOPURETI - taupe-sand



LAGO - taupe-taupe  
 VILA - taupe



**VILA**  
*sun lounger & table*







VILA - white-white



VILA - white-white  
VILA - white  
NAUTIC - white  
EOLO PURETI - white-white

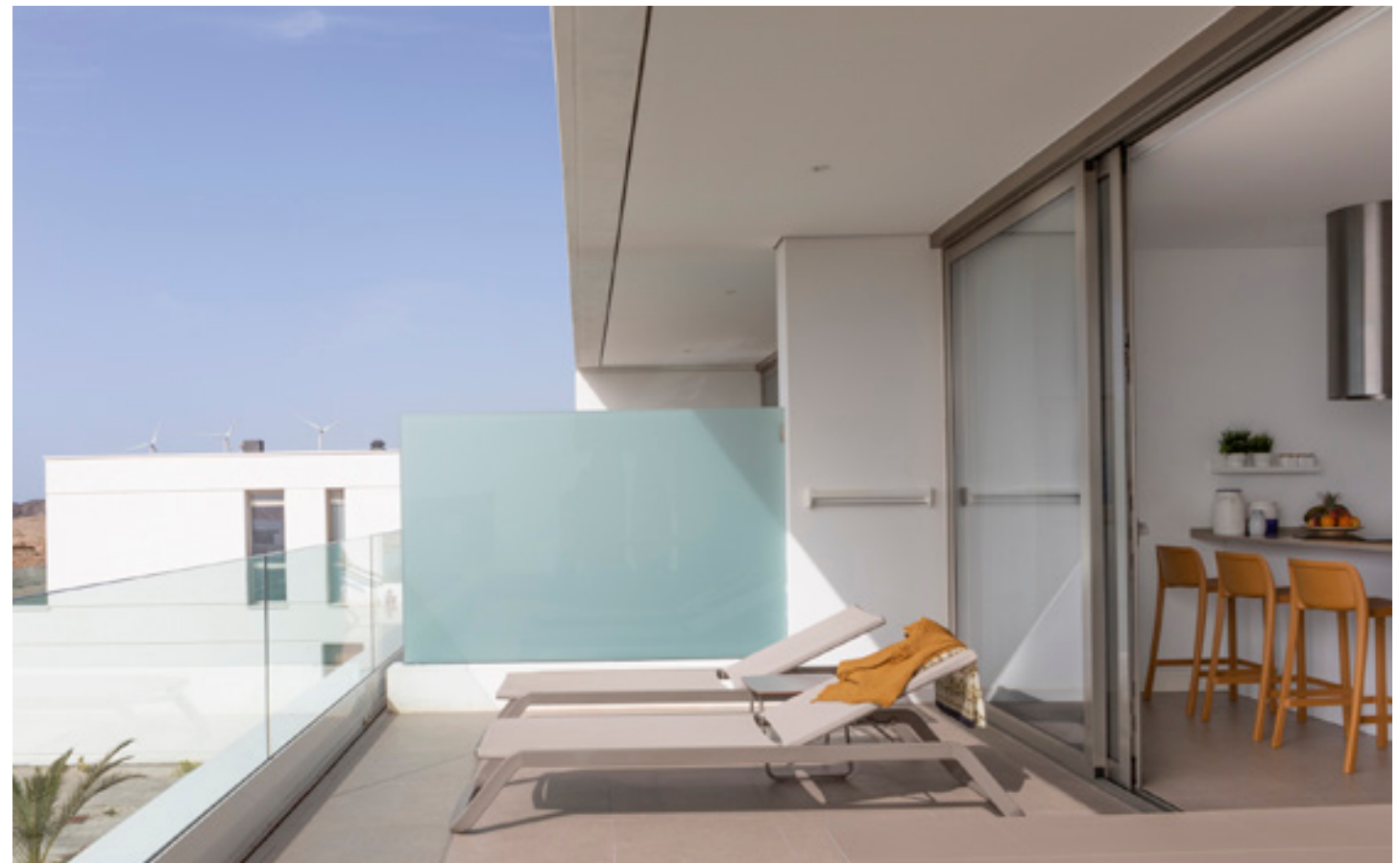

VILA - taupe-taupe  
VILA - taupe  
ATTIC - mustard

VILA - taupe-taupe  
VILA - taupe







NAUTIC - white  
VILA - white-white  
VILA - white  
EOLOPURETI - white-white

# NAUTIC

*cushions*

# AQUA

*cushions*



AQUA - taupe  
VILA - taupe  
VILA - taupe-taupe



# IBIZA & NANA







IBIZA - taupe



# MARINE







MARINE - white



MARINE - white



# SEPARADORES

*Space-dividers*  
*Séparateurs*

**CATARINA**

*16 years in Ezpeleta*

**ES.** Nuestra apuesta por el talento joven y local ha supuesto un gran impulso en nuestro crecimiento, contagiándonos de su ilusión y de su constante espíritu de mejora.

Los separadores Siena son ejemplo de ello, ya que cuentan con una estructura modular compuesta solamente por dos materiales: perfilera de aluminio lacado y uniones de poliamida, facilitando así su montaje y posterior reciclaje.

**EN.** Our commitment to young, local talent has contributed a great deal to our growth, and their enthusiasm and ongoing improvement spirit have been contagious.

Our Siena space-dividers are an example of this, as they feature a modular structure made up of only two materials: lacquered aluminium profiles and polyamide joints, enabling them to be easily assembled and subsequently recycled.

**PT.** A nossa aposta nos jovens talentos locais foi um grande impulso para o nosso crescimento, contagiando-nos com o seu entusiasmo e o seu constante espírito de melhoria.

Os separadores Siena são um exemplo disso mesmo, pois têm uma estrutura modular composta apenas por dois materiais: perfis de alumínio lacado e juntas de poliamida, o que facilita a sua montagem e reciclagem.

**FR.** Notre engagement envers les jeunes talents locaux a largement contribué à notre croissance, en nous transmettant leurs enthousiasmes et leurs esprits d'amélioration constante.

Les séparateurs Siena en sont un exemple, car ils ont une structure modulaire composée de seulement deux matériaux: des profils en aluminium laqué et des joints en polyamide, ce qui les rend faciles à assembler et à recycler.





# SIENA







SIENA - taupe  
 TOWNARMCHAIR - taupe  
 MEET - taupe-dark oak



SIENA - anthracite  
 BAKE - sand-taupe  
 MONACO - taupe-taupe



SIENA - anthracite  
 JARDINERA - black  
 ROD - anthracite-anthracite  
 ATTIC - brick



# PARASOLES

*Guarda-sóis*  
*Parasols*

**PAULA**

*37 years in Ezpeleta*

**ES.** La confección de nuestros parasoles conlleva un proceso de gran componente artesanal llevado a cabo por un equipo de manos expertas, que con precisión van dando forma a cada una de sus piezas y costuras.

Son el reflejo del saber hacer de la familia Ezpeleta, que ha logrado transmitir su experiencia como artesanos paragueros desde 1935 hasta hoy. Un legado que han sabido homenajear generación tras generación, hasta ser reconocidos como grandes referentes en la fabricación de paraguas y parasoles.

**EN.** Manufacturing our parasols requires a highly handcrafted process carried out by a team of expert manual skills, accurately shaping each piece and seam.

They reflect the know-how of the Ezpeleta family, who have successfully transmitted their experience as artisan umbrella makers from 1935 to the present day. This legacy has been successfully honoured generation after generation, to the point of being acknowledged as a benchmark in the manufacture of umbrellas and parasols.

**PT.** O fabrico dos nossos guarda-sóis é um processo muito artesanal realizado por uma equipa de mãos experientes, que moldam cada uma das peças e costuras com precisão.

São o reflexo do saber-fazer da família Ezpeleta, que soube transmitir a sua experiência como fabricante artesanal de guarda-chuvas desde 1935 até aos nossos dias. Um legado que souberam homenagear geração após geração, ao ponto de serem reconhecidos como uma grande referência no fabrico de guarda-chuvas e guarda-sóis.

**FR.** La fabrication de nos parasols est un processus très artisanal réalisé par une équipe de mains expertes, qui façonnent avec précision chacune des pièces et des coutures.

Ils sont le reflet du savoir-faire de la famille Ezpeleta, qui a su transmettre son expérience d'artisan fabricant de parapluies de 1935 à nos jours. Un héritage qu'ils ont su faire fructifier génération après génération, au point d'être reconnus comme une grande référence dans la fabrication de parapluies et d'ombrelles.





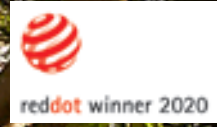

# EOLO PURETI

EL PARASOL QUE PURIFICA EL AIRE  
O GUARDA-SOL QUE PURIFICA O AR  
THE PARASOL THAT PURIFIES THE AIR  
LE PARASOL QUI PURIFIE L'AIR

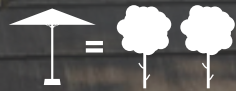





**EOLOPURETI** - taupe-sand  
**CUBE** - white  
**VILA** - taupe-tweed olivo



**EOLOPURETI** - taupe-taupe  
**VILA** - taupe-taupe



**EOLOPURETI** - taupe-sand  
**BOND** - taupe  
**VILA** - taupe-tweed olivo, taupe-taupe  
**VILA** - taupe



**EOLOPURETI** - taupe-taupe  
**BOND** - taupe  
**LAGO** - taupe-taupe  
**VILA** - taupe





EOLO - taupe-sky blue

# EOLO



EOLO - taupe-sky blue





FLE XO - white-white  
URBAN - white-white marble  
ATTIC - white



# FLE XO

FLE XO - white-sand  
VILA - white-taupe  
VILA - white  
HOP - white  
KOS - white-white





**RIO** - anthracite-anthracite  
**FIXRIO** - anthracite

# RIO



**RIO** - white-white  
**DOCK** - taupe  
**MEET** - anthracite-taupe



# FORMENTERA



FORMENTERA - anthracite-taupe  
CROSS - anthracite  
BAKE - sand-taupe  
QUATRO - sand-oak



FORMENTERA LATERAL - anthracite-anthracite  
CANTO - anthracite  
URBAN - anthracite-anthracite  
TRENASTOOL - pearl

# FORMENTERA LATERAL



# VIGO



**VIGO** - taupe stripe  
**ATTIC** - olivo, sand  
**URBAN** - anthracite-oak



**JAVA** - taupe  
**BAKE** - sand-taupe  
**ATTIC** - sand  
**URBAN** - taupe-taupe  
**MEET** - taupe-taupe

# JAVA





MADEIRA - green stripe  
CANTO - rust  
BAKE - sand-taupe  
MEET - taupe-taupe

# MADEIRA

# TENERIFE



TENERIFE - blue stripe  
BOND - white  
PARK - white  
KOS - white-oak





MENORCA - sky blue  
BOND - white  
PARK - white

# MENORCA

# PALMA

PALMA - white  
VILA - taupe-taupe





# ONS



ONS - olivo  
BOND - white  
NOON - taupe  
QUATRO FOLD - taupe-oak

# TOSCANA



TOSCANA - sky blue/sand  
BOND - white  
LAGO - white-white  
VILA - white



# MANILA

MANILA  
FADO - brick, mustard, aquamarine



## Detalles Técnicos - Detalhes Técnicos Technical Details - Détails Techniques



Apilable  
Empilhável  
Stackable  
Empilable



Apilable  
Empilhável  
Stackable  
Empilable



Reguladores de altura  
Adjustable leveling feet  
Vérins réglables



Desenfundable  
Removível  
Removable  
Déhoussable



Abatible  
Rebatível  
Folding  
Pliante



Uso interior  
Indoor use  
Pour l'intérieur



Uso exterior  
Uso ao ar livre  
Outdoor use  
Utilisation en extérieur



Protección UV  
Proteção UV  
UV protection  
Protection UV



Fabricado en la unión europea  
Feito na união europeia  
Made in the european union  
Fabriqué dans l'union européenne



Reciclable  
Reciclável  
Recyclable



Resistente al moho  
Resistente ao bolor  
Mold resistant  
Résistant à la moisissure



Tableros con tratamiento antimicrobiano  
Tampos con tratamento anti-microbiano  
Table-tops with antimicrobial treatment  
Plateau avec traitement antimicrobien



Muy fácil de lavar y desinfectar  
Muito fácil de lavar e desinfectar  
Very easy to clean up and disinfect  
Très facile à laver et à désinfecter

## Confecciones



Con volante con fugavientos  
Com babinela com fugaventos  
With valance with airvent  
Avec volants et soufflet



Sin volante con fugavientos  
Sem babinela com fugaventos  
Without valance with airvent  
Sans volant avec soufflet



Con volante sin fugavientos  
Com babinela sem fugaventos  
With valance without airvent  
Avec volants sans soufflet



Sin volante sin fugavientos  
Sem babinela sem fugaventos  
Without valance without airvent  
Sans volant sans soufflet



Con volante sin fugavientos con flecos  
Com babinela sem fugaventos com franjas  
With valance without airvent with fringes  
Avec volants sans soufflet et avec des franges



Sin volante sin fugavientos con flecos  
Sem babinela sem fugaventos com franjas  
Without valance without airvent with fringes  
Sans volant sans soufflet avec des franges



## TRENA ARMCHAIR

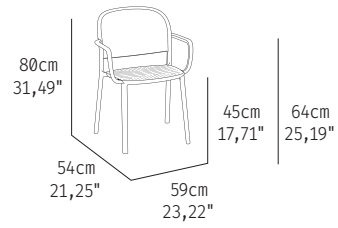

MN-TRE00  
091X00 anthracite



MN-TRE00  
024X00 taupe



MN-TRE00  
026X00 terracota



MN-TRE00  
029X00 blue grey



MN-TRE00  
011X00 soft pink



MN-TRE00  
028X00 pearl



Sillón apilable. Polipropileno reforzado con fibra de vidrio. Inyección por gas. Tacos antiderrapantes.  
Cadeira empilhável. Polipropileno reforçado com fibra de vidro. Injeção por gás. Tacos antiderrapantes.  
Stackable armchair. Fiberglass reinforced polypropylene. Gas injection. Non slip caps.  
Fauteuil empilable. Polypropylène renforcé avec fibre de verre. Injection par gaz. Embouts antidérapants.

Registered design No. 015018296-0002

## TRENA CHAIR

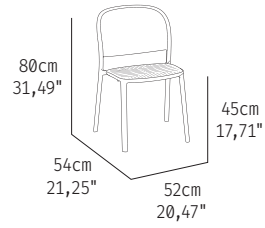

MS-TRE00  
091X00 anthracite



MS-TRE00  
024X00 taupe



MS-TRE00  
026X00 terracota



MS-TRE00  
029X00 blue grey



MS-TRE00  
011X00 soft pink



MS-TRE00  
028X00 pearl



Silla apilable. Polipropileno reforzado con fibra de vidrio. Inyección por gas. Tacos antiderrapantes.  
Cadeira empilhável. Polipropileno reforçado com fibra de vidro. Injeção por gás. Tacos antiderrapantes.  
Stackable chair. Fiberglass reinforced polypropylene. Gas injection. Non slip caps.  
Chaise empilable. Polypropylène renforcé avec fibre de verre. Injection par gaz. Embouts antidérapants.

Registered design No. 015018296-0001

## TRENA STOOL

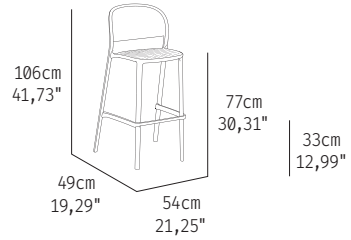

MT-TRE00  
091X00 anthracite



MT-TRE00  
024X00 taupe



MT-TRE00  
026X00 terracota



MT-TRE00  
029X00 blue grey



MT-TRE00  
011X00 soft pink



MT-TRE00  
028X00 pearl



Taburete apilable. Polipropileno reforzado con fibra de vidrio. Inyección por gas. Tacos antiderrapantes.  
Banco alto empilhável. Polipropileno reforçado com fibra de vidro. Injeção por gás. Tacos antiderrapantes.  
Stackable stool. Fiberglass reinforced polypropylene. Gas injection. Non slip caps.  
Tabouret empilable. Polypropylène renforcé avec fibre de verre. Injection par gaz. Embouts antidérapants.

Registered design No. 015018296-0003

## NOON

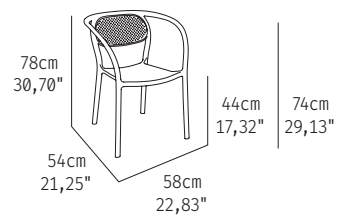

MN-NON00  
024X00 taupe



MN-NON00  
028X00 pearl



MN-NON00  
026X00 terracota



MN-NON00  
029X00 blue grey



Sillón apilable. Polipropileno reforzado con fibra de vidrio. Inyección por gas. Tacos antiderrapantes.  
Cadeira empilhável. Polipropileno reforçado com fibra de vidro. Injeção por gás. Tacos antiderrapantes.  
Stackable armchair. Fiberglass reinforced polypropylene. Gas injection. Non slip caps.  
Fauteuil empilable. Polypropylène renforcé avec fibre de verre. Injection par gaz. Embouts antidérapants.

Registered design No. 015020798-0001





## BAKE WOOD

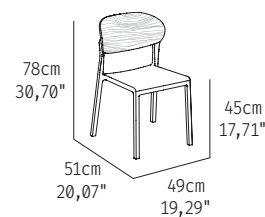

MS-BAK20  
024X00 taupe



MS-BAK20  
071X00 sand



MS-BAK20  
091X00 anthracite



MS-BAK20  
066X00 olivo



## BAKE WOOD PAD

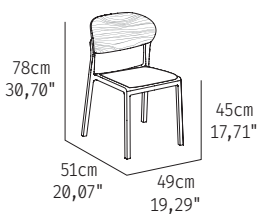

MS-BAK23  
024X-015S0  
taupe-pad taupe



MS-BAK24  
071X-015S0  
sand-pad taupe



MS-BAK21  
091X-015S0  
anthracite-pad taupe



MS-BAK25  
066X-015S0  
olivo-pad taupe



## BAKE

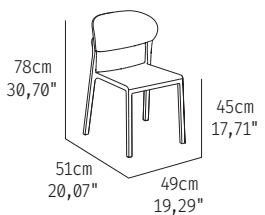

MS-BAK01 anthracite  
029X00 blue grey



MS-BAK04 sand  
024X00 taupe



MS-BAK03 taupe  
026X00 terracota



MS-BAK05 olivo  
028X00 pearl



## BAKE PAD

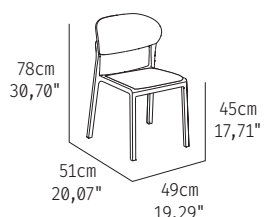

MS-BAK11 anthracite  
029X-015S0  
blue grey-pad taupe



MS-BAK14 sand  
024X-015S0  
taupe-pad taupe



MS-BAK13 taupe  
026X-015S0  
terracota-pad taupe



MS-BAK15 olivo  
028X-015S0  
pearl-pad taupe



EUROPEAN  
PRODUCT  
DESIGN  
AWARD

Silla apilable. Asiento de polipropileno reforzado con fibra de vidrio (inyección por gas). Respaldo de madera chapada en haya en el interior y roble en la cara exterior, fabricado bajo certificación con colas ULEF. Uso interior. Tacos antideslizantes.

*Cadeira empilhável. Assento em polipropileno reforçado com fibra de vidro (injeção por gás). Encosto em madeira folheada em faia na parte interior e carvalho na parte exterior, fabricado com resinas UF de baixa emissão de formaldeído (ULEF). Uso interior. Tacos antiderrapantes.*

Stackable chair. Fibreglass reinforced polypropylene structure (gas injection). The chair back has a beech plywood inner face and oak outer face, produced using certified ULEF. Indoor use. Non slip caps.

*Chaise empilage. siège en polypropylène renforcé avec de la fibre de verre (Injection par gaz). Le dossier en bois de hêtre plaqué sur le côté intérieur et en chêne sur le côté extérieur, fabriqué sous certification avec colles ULEF. Pour l'intérieur. Embouts antidérapants.*

Registered design No. 009083025-0001

Silla. Polipropileno reforzado con fibra de vidrio. Inyección por gas. Asiento de polipropileno tapizado (50% vinilo/50% poliéster). Respaldo de madera chapada en haya en el interior y roble en la cara exterior, fabricado bajo certificación con colas ULEF. Uso interior.

*Cadeira. Polipropileno reforçado com fibra de vidro. Injeção por gás. Assento em polipropileno acolchoado (50% vinil/50% poliéster). Encosto em madeira folheada em faia na parte interior e carvalho na parte exterior, fabricado com resinas UF de baixa emissão de formaldeído (ULEF). Uso interior.*

Chair. Fibreglass reinforced polypropylene. Gas injection. Upholstered polypropylene shell seat (50% vinyl/50% polyester). The chair back has a beech plywood inner face and oak outer face, produced using certified ULEF. Indoor use.

*Chaise. Polypropylène renforcé avec fibre de verre. Injection par gaz. Assise tapissée en polypropylène (50% vinyl/50% polyester). Le dossier en bois de hêtre plaqué sur le côté intérieur et en chêne sur le côté extérieur, fabriqué sous certification avec colles ULEF. Pour l'intérieur.*

Registered design No. 009083025-0001

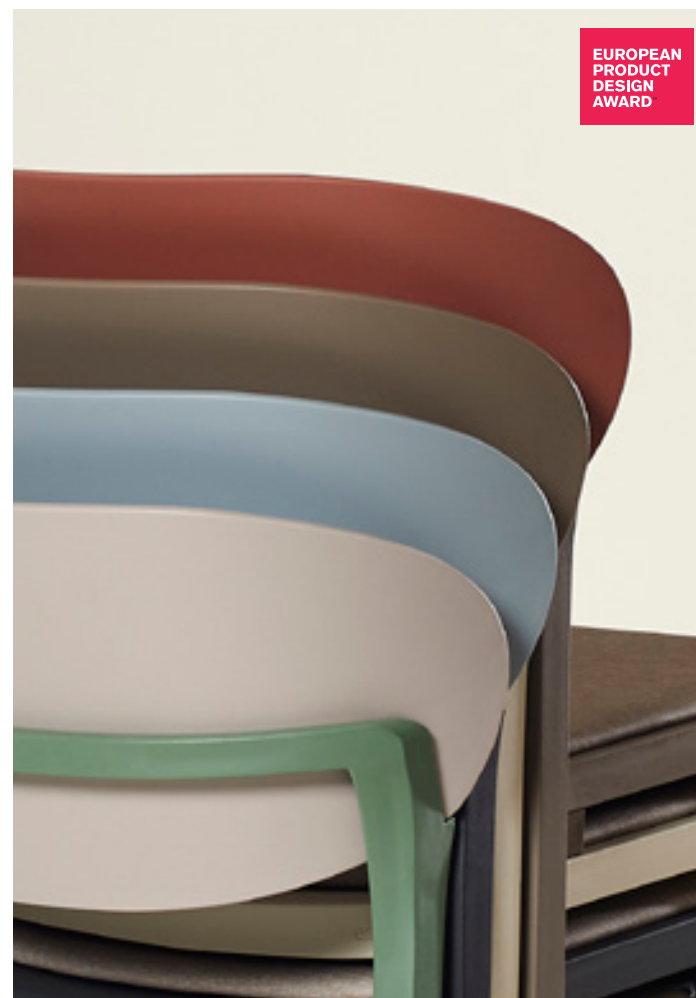

EUROPEAN  
PRODUCT  
DESIGN  
AWARD

Silla apilable. Polipropileno reforzado con fibra de vidrio. Inyección por gas. Tacos antideslizantes.

*Cadeira empilhável. Polipropileno reforçado com fibra de vidro. Injeção por gás. Tacos antiderrapantes.*

Stackable chair. Fibreglass reinforced polypropylene. Gas injection. Non slip caps.

*Chaise empilable. Polypropylène renforcé avec fibre de verre. Injection par gaz. Embouts antidérapants.*

Registered design No. 009083025-0001

Silla. Polipropileno reforzado con fibra de vidrio. Inyección por gas. Asiento de polipropileno tapizado (50% vinilo/50% poliéster). Uso interior. Tacos antideslizantes. Muy fácil de lavar y desinfectar.

*Cadeira. Polipropileno reforçado com fibra de vidro. Injeção por gás. Assento em polipropileno acolchoado (50% vinil/50% poliéster). Uso interior. Tacos antiderrapantes. Muito fácil de lavar e desinfectar.*

Chair. Fibreglass reinforced polypropylene. Gas injection. Upholstered polypropylene shell seat (50% vinyl/50% polyester). Indoor use. Non slip caps. Very easy to clean up and disinfect.

*Chaise. Polypropylène renforcé avec fibre de verre. Injection par gaz. Assise tapissée en polypropylène (50% vinyl/50% polyester). Pour l'intérieur. Embouts antidérapants. Très facile à laver et à désinfecter.*

Registered design No. 009083025-0001



## ROD

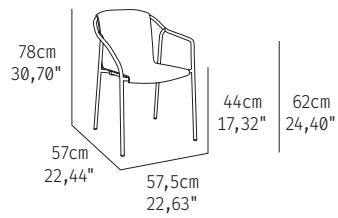

- MN-ROD01 anthracite  
091X00 anthracite
- MN-ROD01 anthracite  
029X00 blue grey
- MN-ROD01 anthracite  
027X00 cappuccino
- MN-ROD03 taupe  
024X00 taupe

**NEW**

**NEW**

- MN-ROD03 taupe  
026X00 terracota
- MN-ROD03 taupe  
028X00 pearl

Sillón apilable. Estructura de aluminio lacado. Asiento de polipropileno. Tacos antideslizantes.  
 Cadeira empilhável. Estrutura em alumínio lacado. Assento em polipropileno. Tacos antiderrapantes.  
 Stackable armchair. Lacquered aluminium frame. Polypropylene shell. Non slip caps.  
 Fauteuil empilable. Structure en aluminium laqué. Assise en polypropylène. Embouts antidérapants.

Registered design No. 006954285

## ROD PAD

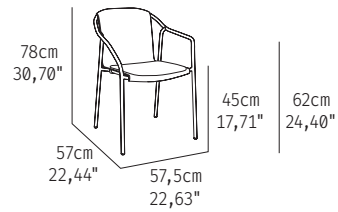

- MN-ROD11 anthracite  
091X-01350 anthracite-pad grey
- MN-ROD11 anthracite  
029X-01350 blue grey-pad grey
- MN-ROD11 anthracite  
027X-01350 cappuccino-pad grey
- MN-ROD13 taupe  
024X-01350 taupe-pad taupe

**NEW**

**NEW**

- MN-ROD13 taupe  
026X-01350 terracota-pad taupe
- MN-ROD13 taupe  
028X-01550 pearl-pad taupe

Sillón. Estructura de aluminio lacado. Asiento de polipropileno tapizado (50% vinilo/50% poliéster). Uso interior. Tacos antideslizantes. Muy fácil de lavar y desinfectar.  
 Cadeira. Estrutura em alumínio lacado. Assento em polipropileno acolchoado (50% vinil/50% poliéster). Uso interior. Tacos antiderrapantes. Muito fácil de lavar e desinfectar.  
 Armchair. Lacquered aluminium frame. Upholstered polypropylene shell seat (50% vinyl/50% polyester). Indoor use. Non slip caps. Very easy to clean up and disinfect.  
 Fauteuil. Structure en aluminium laqué. Assise tapissée en polypropylène (50% vinil/50% polyester). Pour l'intérieur. Embouts antidérapants. Très facile à laver et à désinfecter.

Registered design No. 006954285

## HOP

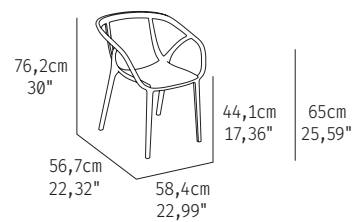

- MN-HOP00  
024X00 taupe
- MN-HOP00  
026X00 terracota
- MN-HOP00  
066X00 olivo
- MN-HOP00  
010X00 white

**NEW**



Sillón apilable. Polipropileno reforzado con fibra de vidrio. Inyección por gas. Tacos antideslizantes.  
 Cadeira empilhável. Polipropileno reforçado com fibra de vidro. Injeção por gás. Tacos antiderrapantes.  
 Stackable armchair. Fiberglass reinforced polypropylene. Gas injection. Non slip caps.  
 Fauteuil empilable. Polypropylène renforcé avec fibre de verre. Injection par gaz. Embouts antidérapants.

## FADO

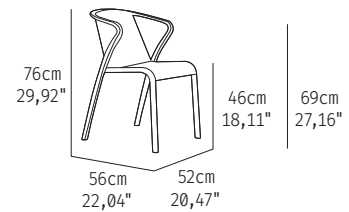

- MN-FAD00  
071X00 sand
- MN-FAD00  
024X00 taupe
- MN-FAD00  
091X00 anthracite
- MN-FAD00  
065X00 brick

- MN-FAD00  
064X00 mustard
- MN-FAD00  
084X00 aquamarine
- MN-FAD00  
066X00 olivo

Sillón apilable. Polipropileno reforzado con fibra de vidrio. Inyección por gas. Tacos antideslizantes.  
 Cadeira empilhável. Polipropileno reforçado com fibra de vidro. Injeção por gás. Tacos antiderrapantes.  
 Stackable armchair. Fiberglass reinforced polypropylene. Gas injection. Non slip caps.  
 Fauteuil empilable. Polypropylène renforcé avec fibre de verre. Injection par gaz. Embouts antidérapants.

Registered design No. 4017226

## ATTIC

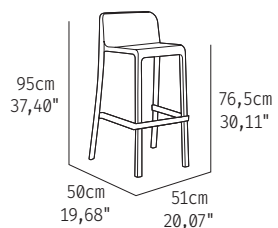

- MT-ATT00  
010X00 white
- MT-ATT00  
071X00 sand
- MT-ATT00  
024X00 taupe
- MT-ATT00  
091X00 anthracite

- MT-ATT00  
065X00 brick
- MT-ATT00  
064X00 mustard
- MT-ATT00  
084X00 aquamarine
- MT-ATT00  
066X00 olivo

Taburete apilable. Polipropileno reforzado con fibra de vidrio. Inyección por gas. Tacos antideslizantes.  
 Banco alto empilhável. Polipropileno reforçado com fibra de vidro. Injeção por gás. Tacos antiderrapantes.  
 Stackable stool. Fiberglass reinforced polypropylene. Gas injection. Non slip caps.  
 Tabouret empilable. Polypropylène renforcé avec fibre de verre. Injection par gaz. Embouts antidérapants.

Registered design No. 4016665



## TOWN ARMCHAIR

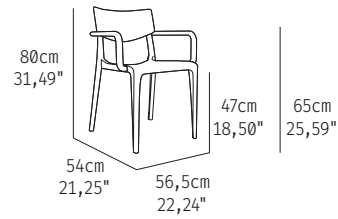

MN-TOW00  
010X00 white



MN-TOW00  
024X00 taupe



MN-TOW00  
091X00 anthracite



MN-TOW00  
065X00 brick



MN-TOW00  
064X00 mustard



MN-TOW00  
066X00 olivo



Sillón apilable. Polipropileno reforzado con fibra de vidrio. Inyección por gas. Tacos antideslizantes.  
Cadeira empilhável. Polipropileno reforçado com fibra de vidro. Injeção por gás. Tacos antiderrapantes.  
Stackable armchair. Fiberglass reinforced polypropylene. Gas injection. Non slip caps.  
Fauteuil empilable. Polypropylène renforcé avec fibre de verre. Injection par gaz. Embouts antidérapants.

Registered design No. 2747774

## TOWN CHAIR

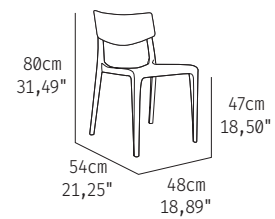

MS-TOW00  
010X00 white



MS-TOW00  
024X00 taupe



MS-TOW00  
091X00 anthracite



MS-TOW00  
065X00 brick



MS-TOW00  
064X00 mustard



MS-TOW00  
066X00 olivo



Silla apilable. Polipropileno reforzado con fibra de vidrio. Inyección por gas. Tacos antideslizantes.  
Cadeira empilhável. Polipropileno reforçado com fibra de vidro. Injeção por gás. Tacos antiderrapantes.  
Stackable chair. Fiberglass reinforced polypropylene. Gas injection. Non slip caps.  
Chaise empilable. Polypropylène renforcé avec fibre de verre. Injection par gaz. Embouts antidérapants.

Registered design No. 2747774

## TOWN ARMCHAIR PAD

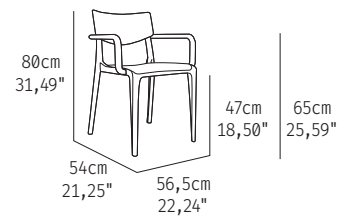

MN-TOW10  
010X - 015S01  
white-taupe



MN-TOW10  
024X - 015S0  
taupe-taupe



MN-TOW10  
091X - 013S0  
anthracite-grey



MN-TOW10  
065X - 015S0  
brick-taupe



MN-TOW10  
064X - 015S0  
mustard-taupe



MN-TOW10  
066X - 013S0  
olivo-grey



Sillón. Polipropileno reforzado con fibra de vidrio. Inyección por gas. Asiento tapizado (50% vinilo/50% poliéster). Uso interior. Tacos antideslizantes. Muy fácil de lavar y desinfectar.  
Cadeira. Polipropileno reforçado com fibra de vidro. Injeção por gás. Assento acolchoado (50% vinil/50% poliéster). Uso interior. Tacos antiderrapantes. Muito fácil de lavar e desinfectar.  
Armchair. Fiberglass reinforced polypropylene. Gas injection. Upholstered seat (50% vinyl/50% polyester). Indoor use. Non slip caps. Very easy to clean up and disinfect.  
Fauteuil. Polypropylène renforcé avec fibre de verre. Injection par gaz. Assise tapissée (50%vinyl/50% polyester). Pour l'intérieur. Embouts antidérapants. Très facile à laver et à désinfecter.

Registered design No. 2747774

## TOWN CHAIR PAD

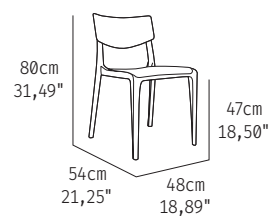

MS-TOW10  
010X - 015S0  
white-taupe



MS-TOW10  
024X - 015S0  
taupe-taupe



MS-TOW10  
091X - 013S0  
anthracite-grey



MS-TOW10  
065X - 015S0  
brick-taupe



MS-TOW10  
064X - 015S0  
mustard-taupe



MS-TOW10  
066X - 013S0  
olivo-grey



Silla. Polipropileno reforzado con fibra de vidrio. Inyección por gas. Asiento tapizado (50% vinilo/50% poliéster). Uso interior. Tacos antideslizantes. Muy fácil de lavar y desinfectar.  
Cadeira. Polipropileno reforçado com fibra de vidro. Injeção por gás. Assento acolchoado (50% vinil/50% poliéster). Uso interior. Tacos antiderrapantes. Muito fácil de lavar e desinfectar.  
Chair. Fiberglass reinforced polypropylene. Gas injection. Upholstered seat (50% vinyl/50% polyester). Indoor use. Non slip caps. Very easy to clean up and disinfect.  
Chaise. Polypropylène renforcé avec fibre de verre. Injection par gaz. Assise tapissée (50%vinyl/50% polyester). Pour l'intérieur. Embouts antidérapants. Très facile à laver et à désinfecter.

Registered design No. 2747774



## PARK ARMCHAIR

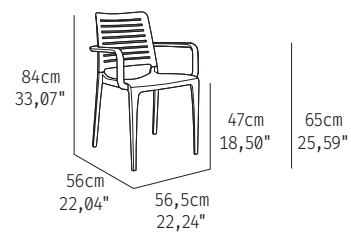

Sillón apilable. Polipropileno reforzado con fibra de vidrio. Inyección por gas. Tacos antideslizantes.  
 Cadeira empilhável. Polipropileno reforçado com fibra de vidro. Injeção por gás. Tacos antiderrapantes.  
 Stackable armchair. Fiberglass reinforced polypropylene. Gas injection. Non slip caps.  
 Fauteuil empilable. Polypropylène renforcé avec fibre de verre. Injection par gaz. Embouts antidérapants.

Registered design No. 2747774



## DOCK

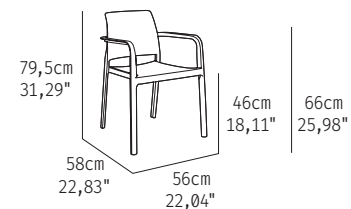

Sillón apilable. Polipropileno reforzado con fibra de vidrio. Inyección por gas. Tacos antideslizantes.  
 Cadeira empilhável. Polipropileno reforçado com fibra de vidro. Injeção por gás. Tacos antiderrapantes.  
 Stackable armchair. Fiberglass reinforced polypropylene. Gas injection. Non slip caps.  
 Fauteuil empilable. Polypropylène renforcé avec fibre de verre. Injection par gaz. Embouts antidérapants.

Registered design No. 3190040



## LAND

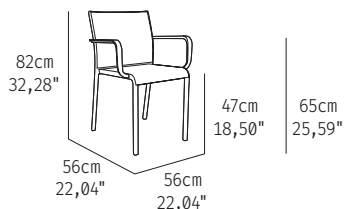

Sillón apilable. Aluminio lacado. Tejido Phiferter®. Tacos antideslizantes.  
 Cadeira empilhável. Alumínio lacado. Tecido Phiferter®. Tacos antiderrapantes.  
 Stackable armchair. Lacquered aluminium. Phiferter® fabric. Non slip caps.  
 Fauteuil empilable. Aluminium laqué. Toile Phiferter®. Embouts antidérapants.





## MEET

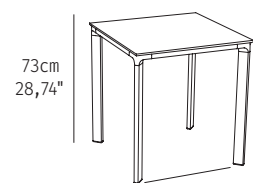

57-67-77cm  
22,44-26,37-30,31"





70x70cm - 27,55x27,55"



80x80cm - 31,49x31,49"



90x90cm - 35,43x35,43"

white  40MEE04 MHK-MEEC07004  
taupe  40MEE06 MHK-MEEC07006  
anthracite  40MEE05 MHK-MEEC07005

40MEE14 MHK-MEEC08004  
40MEE16 MHK-MEEC08006  
40MEE15 MHK-MEEC08005

40MEE24 MHK-MEEC09004K  
40MEE26 MHK-MEEC09006K  
40MEE25 MHK-MEEC09005K

Mesa apilable. Estructura de aluminio lacado. Perfil de 58x25x1,6mm - 2,28x0,98x0,06" con uniones en fundición de aluminio.

Mesa empilhável. Estrutura de alumínio lacado. Perfil de 58x25x1,6mm - 2,28x0,98x0,06" com uniões em alumínio fundido.

Stackable table. Lacquered aluminium frame. 58x25x1,6mm - 2,28x0,98x0,06" profiles with die cast aluminium links.

Table empilable. Structure en aluminium laqué. Profile de 58x25x1,6mm - 2,28x0,98x0,06" assemblée avec de l'aluminium fondu.

## MEET

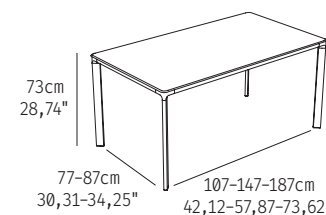

77-87cm  
30,31-34,25" 107-147-187cm  
42,12-57,87-73,62"





120x80cm - 47,24x31,49"



160x90cm - 42,99x35,43"



200x90cm - 78,74x35,43"

white  40MEE104 MHK-MEEH12004K  
taupe  40MEE106 MHK-MEEH12006K  
anthracite  40MEE105 MHK-MEEH12005K

40MEE204 MHK-MEEH16004K  
40MEE206 MHK-MEEH16006K  
40MEE205 MHK-MEEH16005K

40MEE304 MHK-MEEH20004K  
40MEE306 MHK-MEEH20006K  
40MEE305 MHK-MEEH20005K

Mesa dining. Estructura de aluminio lacado. Perfil de 58x25x1,6mm - 2,28x0,98x0,06" con uniones en fundición de aluminio.

Mesa dining. Estrutura de alumínio lacado. Perfil de 58x25x1,6mm - 2,28x0,98x0,06" com uniões em alumínio fundido.

Dinning table. Lacquered aluminium frame. 58x25x1,6mm - 2,28x0,98x0,06" profiles with die cast aluminium links.

Table dining. Structure en aluminium laqué. Profile de 58x25x1,6mm - 2,28x0,98x0,06" assemblée avec de l'aluminium fondu.

## MONACO

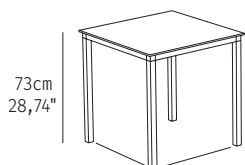

67-77cm  
26,37-30,31" 67-77-107cm  
26,37-30,31-42,12"







70x70cm - 27,55x27,55"



80x80cm - 31,49x31,49"



120x80cm - 47,24x31,49"

white  40MOT04 MHK-MOTC07004  
sand  40MOT08 MHK-MOTC07008  
taupe  40MOT06 MHK-MOTC07006  
anthracite  40MOT05 MHK-MOTC07005  
moka  40MOT07 MHK-MOTC07007

40MOT14 MHK-MOTC08004  
40MOT18 MHK-MOTC08008  
40MOT16 MHK-MOTC08006  
40MOT15 MHK-MOTC08005  
40MOT17 MHK-MOTC08007

40MOT104 MHK-MOTH12004K  
40MOT108 MHK-MOTH12008K  
40MOT106 MHK-MOTH12006K  
40MOT105 MHK-MOTH12005K  
40MOT107 MHK-MOTH12007K

Mesa apilable. Estructura de aluminio lacada con uniones de poliamida con fibra de vidrio. Reguladores de altura.

Mesa empilhável. Estrutura lacada com uniões em poliamida com fibra de vidro. Reguladores de altura.

Stackable table. Lacquered aluminium frame with polyamide with fiberglass connecting pieces. Adjustable leveling feet.

Table empilable. Structure en aluminium laqué avec assemblée en polyamide avec fibre de verre. Pieds sur vérins réglables.

Utility model No. U202030013

## URBAN

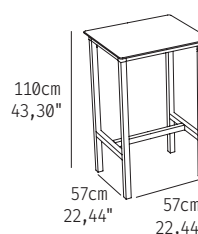

57cm  
22,44" 57cm  
22,44"



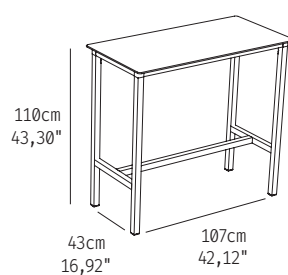

70x70cm - 27,55x27,55\*\*



43cm  
16,92" 107cm  
42,12"



120x60cm - 47,24x23,62"

white  40URT19 MLK-URTC07009  
taupe  40URT17 MLK-URTC07007  
anthracite  40URT15 MLK-URTC07005

40URT29 MLK-URTH12009  
40URT27 MLK-URTH12007  
40URT25 MLK-URTH12005

Mesa alta. Estructura de aluminio lacada con uniones de poliamida con fibra de vidrio. Reguladores de altura.

Mesa alta. Estrutura lacada com uniões em poliamida com fibra de vidro. Reguladores de altura.

High table. Lacquered aluminium frame with polyamide with fiberglass connecting pieces. Adjustable leveling feet.

Table haute. Structure en aluminium laqué assemble en polyamide avec fibre de verre. Pieds sur vérins réglables.

Utility model No. U202030013



## QUATRO FOLD

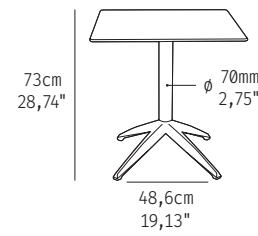

white	
sand	
taupe	
anthracite	
moka	

40QUA00	40QUA04	40QUA03	40QUA01	40QUA02
MHK-QUAC06000	MHK-QUAC06004	MHK-QUAC06003	MHK-QUAC06001	MHK-QUAC06002
MHK-QUAC07000	MHK-QUAC07004	MHK-QUAC07003	MHK-QUAC07001	MHK-QUAC07002
MHK-QUAR06000	MHK-QUAR06004	MHK-QUAR06003	MHK-QUAR06001	MHK-QUAR06002



ø 70 - 27,55"
MHK-QUAR07000
MHK-QUAR07004
MHK-QUAR07003
MHK-QUAR07001
MHK-QUAR07002



Mesa abatible. Patas de polipropileno reforzado con fibra de vidrio. Tubo de aluminio lacado. Reguladores de altura.  
 Mesa rebatível. Pés de polipropileno reforçado com fibra de vidro. Tubo de alumínio lacado. Reguladores de altura.  
 Folding table. Legs in Fiberglass reinforced polypropylene. Lacquered aluminium tube. Adjustable leveling feet.  
 Table pliante. Piètement en polypropylène renforcé avec fibre de verre. Tube aluminium laqué. Pieds sur vérins réglables.

Registered design No.3184670

## QUATRO FIX

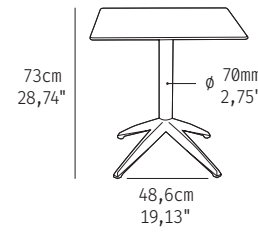

taupe	
anthracite	

40QUF03	40QUF01	MHK-QUFC07003	MHK-QUFC07001	MHK-QUFC08003
MHK-QUFC06003	MHK-QUFC06001	MHK-QUFC07003	MHK-QUFC07001	MHK-QUFC08003
MHK-QUFC07003	MHK-QUFC07001	MHK-QUFC07003	MHK-QUFC07001	MHK-QUFC08003
MHK-QUFC08003	MHK-QUFC08001	MHK-QUFC08003	MHK-QUFC08001	MHK-QUFC08003



ø 80cm - 31,49"
MHK-QUFR08003
MHK-QUFR08001

NEW

Mesa fija. Patas de polipropileno reforzado con fibra de vidrio. Tubo de aluminio lacado. Reguladores de altura.  
 Mesa fixa. Pés de polipropileno reforçado com fibra de vidro. Tubo de alumínio lacado. Reguladores de altura.  
 Fix table. Legs in Fiberglass reinforced polypropylene. Lacquered aluminium tube. Adjustable leveling feet.  
 Table fixe. Piètement en polypropylène renforcé avec fibre de verre. Tube aluminium laqué. Pieds sur vérins réglables.

Registered design No.3184670

\*Pesos para mayor estabilidad. Pesos para maior estabilidade. Ballast to add stability. Leste's pour plus de stabilité.

## QUATRO HIGH FIX

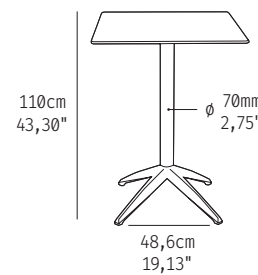

white	
sand	
taupe	
anthracite	
moka	

40QUF10	40QUF14	40QUF13	40QUF11
MLK-QUFC06010	MLK-QUFC06014	MLK-QUFC06013	MLK-QUFC06011
MLK-QUFC07010	MLK-QUFC07014	MLK-QUFC07013	MLK-QUFC07011
MLK-QUFR06010	MLK-QUFR06014	MLK-QUFR06013	MLK-QUFR06011



ø 70 - 27,55"
MLK-QUFR07010
MLK-QUFR07014
MLK-QUFR07013
MLK-QUFR07011
MLK-QUFR07012



Mesa alta fija. Patas de polipropileno reforzado con fibra de vidrio. Tubo de aluminio lacado. Reguladores de altura. Pesos para mayor estabilidad.  
 Mesa alta fixa. Pés de polipropileno reforçado com fibra de vidro. Tubo de alumínio lacado. Reguladores de altura. Pesos para maior estabilidade.  
 High fix table. Legs in Fiberglass reinforced polypropylene. Lacquered aluminium tube. Adjustable leveling feet. Ballast to add stability.  
 Table haut fixe. Piètement en polypropylène renforcé avec fibre de verre. Tube aluminium laqué. Pieds sur vérins réglables. Leste's pour plus de stabilité.

Registered design No.3184670

## QUATRO DUO FIX

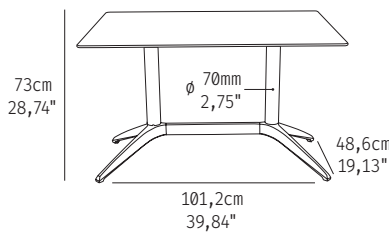

white	
sand	
taupe	
anthracite	

40QUF000	40QUF001
MHK-QUFH12000	MHK-QUFH12001
MHK-QUFH12004	MHK-QUFH12003
MHK-QUFH12003	MHK-QUFH12001

Mesa fija. Patas de polipropileno reforzado con fibra de vidrio. Tubo de aluminio lacado. Reguladores de altura.  
 Mesa fixa. Pés de polipropileno reforçado com fibra de vidro. Tubo de alumínio lacado. Reguladores de altura.  
 Fix table. Legs in Fiberglass reinforced polypropylene. Lacquered aluminium tube. Adjustable leveling feet.  
 Table fixe. Piètement en polypropylène renforcé avec fibre de verre. Tube aluminium laqué. Pieds sur vérins réglables.

Registered design No.3184670



## ONE

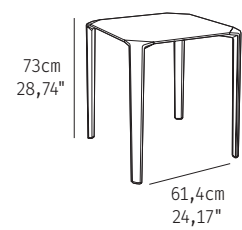

white		42ONE10	MHK-ONEC07000
sand		42ONE15	MHK-ONEC07005
taupe		42ONE12	MHK-ONEC07002
anthracite		42ONE11	MHK-ONEC07001



70x70cm - 27,55x27,55"



Mesa apilable. Patas de polipropileno reforzado con fibra de vidrio. Inyección por gas.

Mesa empilhável. Pés de polipropileno reforçado com fibra de vidro. Injeção por gás.

Stackable table. Legs in Fiberglass reinforced polypropylene. Gas injection.

Table empilable. Piètement en polypropylène renforcé avec fibre de verre. Injection par gaz.

Registered design No. 2747972



## RODAS

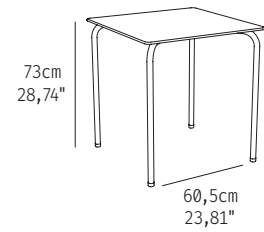

white		40BR001	MHK-BROC07000
taupe		40TR000	MHK-TROC07000
anthracite		40AR000	MHK-AROC07000



70x70cm - 27,55x27,55"

Mesa apilable. Tubo acero lacado.

Mesa empilhável. Tubo aço lacado.

Stackable table. Lacquered steel tube.

Table empilable. Tube acier laqué.

## KOS

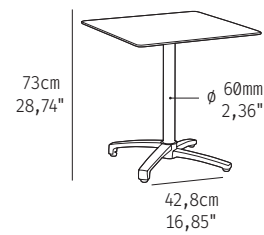

white		42KOS00	MHK-KOSC06000	MHK-KOSC07000	MHK-KOSR06000	MHK-KOSR07000
taupe		42KOS01	MHK-KOSC06001	MHK-KOSC07001	MHK-KOSR06001	MHK-KOSR07001
anthracite		42KOS02	MHK-KOSC06002	MHK-KOSC07002	MHK-KOSR06002	MHK-KOSR07002



60x60cm - 23,62x23,62"



70x70cm - 27,55x27,55"



ø60cm - 23,62"



ø70 - 27,55"

Mesa abatible. Pata aluminio lacado. Reguladores de altura.

Mesa rebatível. Pé alumínio lacado. Reguladores de altura.

Folding table. Lacquered aluminium leg. Adjustable leveling feet.

Table pliante. Pied aluminium laqué. Sur vérins réglables.





# COMPACT

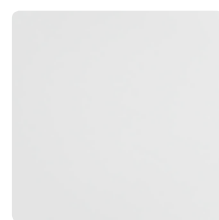

WHITE  
010K00

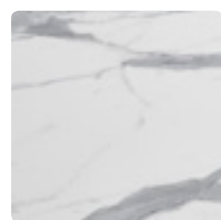

WHITE MARBLE  
013K00

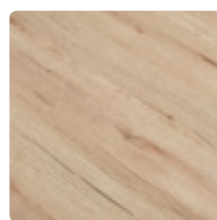

OAK  
092K00

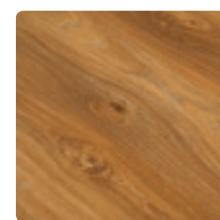

DARK OAK  
093K00

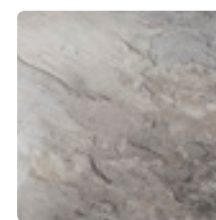

STONE  
028K00



TAUPE  
020K00

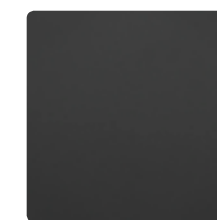

ANTHRACITE \*  
091K00

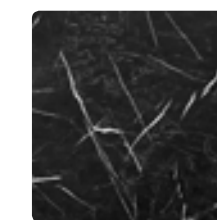

BLACK MARBLE \*  
094K00

60x60cm 23,62x23,62"	■	45K00C06000-010K00	45K00C06000-013K00	45K00C06000-092K00
70x70cm 27,55x27,55"	□	45K00C07000-010K00	45K00C07000-013K00	45K00C07000-092K00
80x80cm 31,49x31,49"	■	45K00C08000-010K00	45K00C08000-013K00	45K00C08000-092K00
90x90cm 35,43x35,43"	□	45K00C09000-010K00		
120x80cm 47,24x31,49"	■	45K00H12000-010K00	45K00H12000-013K00	45K00H12000-092K00
160x90cm 42,99x35,43"	□	45K00H16001-010K00		
200x90cm 78,74x35,43"	■	45K00H20000-010K00		
ø 60cm - 23,62"	○	45K00R06000-010K00		45K00R06000-092K00
ø 70 - 27,55"	●	45K00R07000-010K00		45K00R07000-092K00
ø 80cm - 31,49"	○	45K00R08000-010K00	45K00R08000-013K00	45K00R08000-092K00
120x60cm 47,24x23,62" (urban)	■	45K00H12001-010K00	45K00H12001-013K00	45K00H12001-092K00
70x70cm 27,55x27,55" (one)	□	45K00C07001-010K00	45K00C07001-013K00	45K00C07001-092K00

45K00C06000-093K00	45K00C06000-028K00	45K00C06000-020K00	45K00C06000-091K00	45K00C06000-094K00
45K00C07000-093K00	45K00C07000-028K00	45K00C07000-020K00	45K00C07000-091K00	45K00C07000-094K00
45K00C08000-093K00	45K00C08000-028K00	45K00C08000-020K00	45K00C08000-091K00	45K00C08000-094K00
	45K00C09000-028K00	45K00C09000-020K00	45K00C09000-091K00	
45K00H12000-093K00	45K00H12000-028K00	45K00H12000-020K00	45K00H12000-091K00	45K00H12000-094K00
	45K00H16001-028K00	45K00H16001-020K00	45K00H16001-091K00	
	45K00H20000-028K00	45K00H20000-020K00	45K00H20000-091K00	
45K00R06000-093K00		45K00R06000-020K00		
45K00R07000-093K00		45K00R07000-020K00		
45K00R08000-093K00	45K00R08000-028K00	45K00R08000-020K00	45K00R08000-091K00	45K00R08000-094K00
45K00H12001-093K00	45K00H12001-028K00	45K00H12001-020K00	45K00H12001-091K00	45K00H12001-094K00
45K00C07001-093K00	45K00C07001-028K00	45K00C07001-020K00	45K00C07001-091K00	45K00C07001-094K00

Tablero termolaminado compacto decorativo (10mm - 0,39"). Formado en la cara exterior por papel decorativo impregnado y en el interior por papel kraft impregnado con resinas termoestables. A este material se le aplica en la prensa temperatura y presión de forma simultánea para conseguir un tablero compacto de alta densidad.

Decorative pressed laminated table top (10mm - 0,39"). Interior composed of thermostable resin kraft paper and surface lined with impregnated decorative paper. The compound is pressed simultaneously at high temperature and pressure to obtain a high density compacted table top.

Tampo termolaminado compacto decorativo (10mm - 0,39"). A sua face exterior é formada por papel decorativo impregnado e o seu interior por papel kraft impregnado com resinas termoestáveis. O conjunto é prensado por meio de calor e alta pressão de forma simultânea para conseguir um tampo compacto de alta densidade.

Plateau stratifié compact décoratif (10mm - 0,39"). Formé sur sa face extérieure par du papier décoratif imprégné et dans son intérieur par du papier kraft imprégné avec des résines thermostables. L'ensemble est ensuite pressé sous l'action de la chaleur et de la haute pression, simultanément, afin d'obtenir un plateau compact de haute densité.



Tableros con tratamiento antimicrobial  
Tampos con tratamiento anti-microbiano  
Table-tops with antimicrobial treatment  
Plateau avec traitement antimicrobien

\* No se recomiendan los colores oscuros para zonas muy soleadas - Não se recomendam cores escuras para zonas muito soalheiras - Dark colors are not recommended for very sunny areas - Les couleurs foncées ne sont pas recommandées pour les zones très ensoleillées.



## LAGO

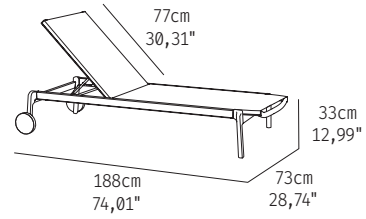

MU-LAG00  
010T11 white/white



MU-LAG00  
020T11 taupe/taupe



MU-LAG00  
066T11 taupe/tweed olivo



Tumbona apilable. Estructura de aluminio lacado. Patas de polipropileno reforzado con fibra de vidrio. Tejido Phifertex®. Respaldo abatible 5 posiciones. Ruedas.

Espreguiçadeira empilhável. Estrutura alumínio lacado. Pés de polipropileno reforçado com fibra de vidro. Tecido Phifertex®. Encosto rebatível 5 posições. Rodas.

Stackable sun lounger. Lacquered aluminium structure. Legs in fiberglass reinforced polypropylene. Phifertex® fabric. Reclining backrest with 5 positions. Wheels.

Bain de soleil empilable. Structure aluminium laqué. Piétement en polypropylène renforcé avec fibre de verre. Toile Phifertex®. Dossier rabattable 5 positions. Roues.

Registered design No. 008735179

## VILA

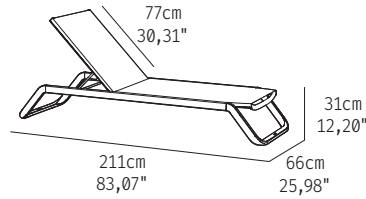

MU-VLA00  
010T11 white/white



MU-VLA02  
020T11 white/taupe



MU-VLA00  
020T11 taupe/taupe



MU-VLA00  
091T11 anthracite/anthracite



MU-VLA00  
066T11 taupe/tweed olivo

Tumbona apilable. Estructura de aluminio lacado. Patas de polipropileno reforzado con fibra de vidrio. Tejido Phifertex®. Respaldo abatible 5 posiciones. Ruedas.

Espreguiçadeira empilhável. Estrutura alumínio lacado. Pés de polipropileno reforçado com fibra de vidro. Tecido Phifertex®. Encosto rebatível 5 posições. Rodas.

Stackable sun lounger. Lacquered aluminium structure. Legs in fiberglass reinforced polypropylene. Phifertex® fabric. Reclining backrest with 5 positions. Wheels.

Bain de soleil empilable. Structure aluminium laqué. Piétement en polypropylène renforcé avec fibre de verre. Toile Phifertex®. Dossier rabattable 5 positions. Roues.

Registered design No. 4410330 - Utility model No. U201731460

## VILA

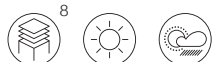
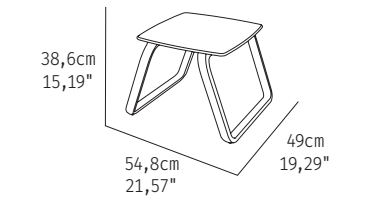

MAK-VLAC04505  
white



MAK-VLAC04506  
taupe



MAK-VLAC04507  
anthracite



Mesa auxiliar apilable. Patas de polipropileno reforzado con fibra de vidrio. Tablero compacto.

Mesa auxiliar empilhável. Pés de polipropileno reforçado com fibra de vidro. Tampo compacto.

Stackable side table. Legs in fiberglass reinforced polypropylene. Compact table top.

Table auxiliaire empilable. Piétement en polypropylène renforcé avec fibre de verre. Plateaux compact.

Registered design No. 006954285

## AQUA & NAUTIC

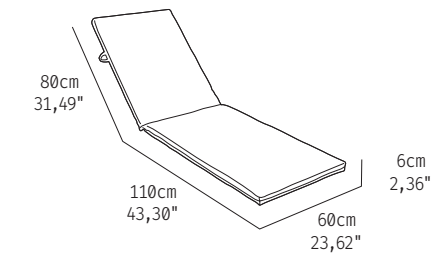

CTQT00681001P1  
003T00 white  
(AQUA)



CTQT00681001P1  
020T00 taupe  
(AQUA)



CTQT00681001P1  
001T00 beige  
(AQUA)



CTEP07681001C1  
010P07 white  
(NAUTIC)



CTEP07681001C1  
020P07 taupe  
(NAUTIC)

Cojines AQUA\*. Textilene. Permeable al agua.

Almofadas AQUA\*. Textilene. Permeável à água.

AQUA Cushions\*. Textilene. Water permeable.

Coussins AQUA\*. Textilene. Perméable à l'eau.

Cojines NAUTIC\*. Tejido náutico. Repelente al agua.

Almofadas NAUTIC\*. Tecido náutico. Repelente à água.

NAUTIC\* Cushions. Nautic fabric. Water repellent.

Coussins NAUTIC\*. Toile Nautic. Deperlante.



## NANA

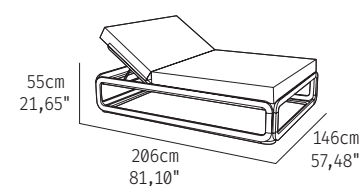

MQ-NANH1400BC  
white



MQ-NANH1400TP  
taupe



Estructura aluminio lacado. Tornillería acero inox lacada. Conexiones en poliamida con fibra de vidrio. Colchón tejido New Nautic\*. Abatible.  
Estrutura alumínio lacado. Parafusos aço inox lacado. Conexões em poliamida com fibra de vidro. Colchão tecido New Nautic\*. Rebatível.  
Lacquered aluminium structure. Lacquered stainless steel screws. Polyamide with fiberglass connecting pieces. New Nautic\* mattress. Folding.  
Structure aluminium laqué. Visserie acier inox laqué. Connexions en polyamide avec fibre de verre. Matelas Toile New Nautic\*. Pliant.

## IBIZA

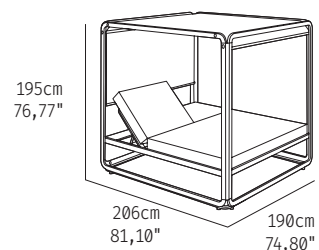

MQ-IBID70H1800BC  
white  
303D70 linen sand



MQ-IBID70H1800TP  
taupe  
303D70 linen sand

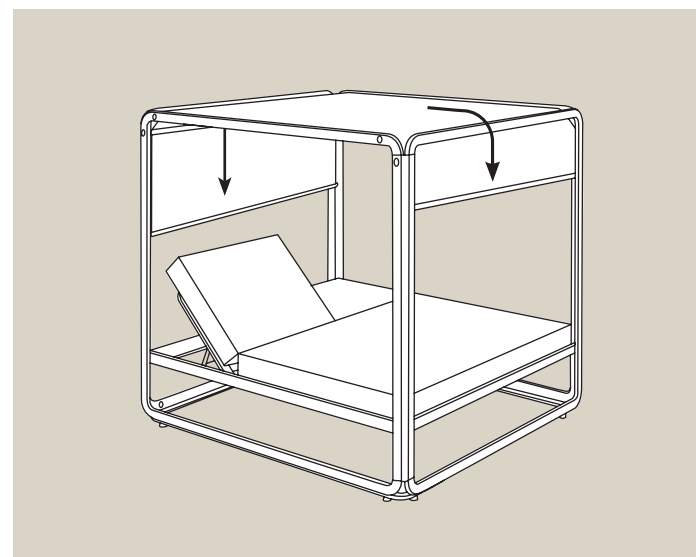

Estructura aluminio lacado. Tornillería acero inox lacada. Conexiones en poliamida con fibra de vidrio. Tejido acrílico tintado en masa. Colchón tejido New Nautic\*. Abatible.  
Estrutura alumínio lacado. Parafusos aço inox lacado. Conexões em poliamida com fibra de vidro. Tecido acrílico tingido em massa. Colchão tecido New Nautic\*. Rebatível.  
Lacquered aluminium structure. Lacquered stainless steel screws. Polyamide with fiberglass connecting pieces. Solution dyed acrylic fabric. New Nautic\* mattress. Folding.  
Structure aluminium laqué. Visserie acier inox laqué. Connexions en polyamide avec fibre de verre. Acrylique teinté en masse. Matelas Toile New Nautic\*. Pliant.



### Toldo/canopy/store - IBIZA - IGAD70H180IBI01

- Tejido hidrófugo 100% acrílico tintado en masa (240gr), repelente al agua. Protección UV50+. Alta solidez a la luz (7-8 sobre 8).
- Tecido 100% acrílico tingido em massa (240gr), repelente à água. Proteção UV50+. Elevada resistência à luz (7-8 em 8).
- Water repellent 100% solution dyed acrylic fabric (240gr). UV50+ protection. High light fastness (7-8 out of 8).
- Tissu acrylique 100% teinté en masse (240gr), déperlant. Protection UV50+. Haute résistance à la lumière (7-8 sur 8).

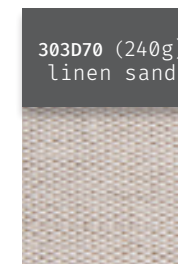

### Cortinas/curtains/rideaux - IBIZA - IGAD02IBI01

- Tejido 100% acrílico tintado en masa (130gr). Alta solidez a la luz (7-8 sobre 8).
- Tecido 100% acrílico tingido em massa (130gr). Elevada solidez a luz (7-8 em 8).
- 100% acrylic solution dyed fabric (130gr). High light fastness (7-8 out of 8).
- Tissu 100% acrylique teinté en masse (130gr). Grande solidité à la lumière (7-8 sur 8).





## MARINE SINGLE SOFA

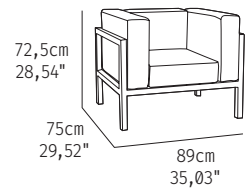

MF-MAR01-010A02  
010P07 white nautic

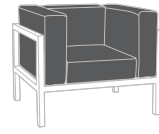

CPF-MARP07280P  
SET 4 cojines - almofadas - cushions - coussins  
010P07 white nautic

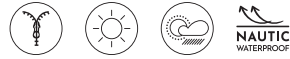

## MARINE CORNER SOFA

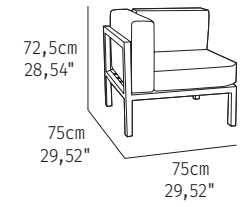

MF-MAR00-010A02  
010P07 white nautic

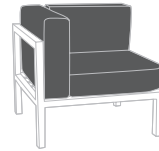

CPF-MARP07282P  
SET 3 cojines - almofadas - cushions - coussins  
010P07 white nautic

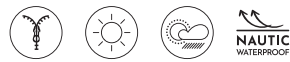

## MARINE IN-BETWEEN SOFA

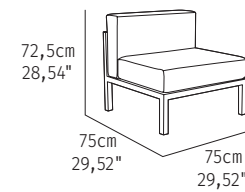

MF-MAR04-010A02  
010P07 white nautic



CPF-MARP07283P  
SET 2 cojines - almofadas - cushions - coussins  
010P07 white nautic

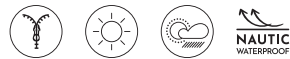

## MARINE POUF

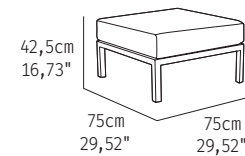

MC-MAR00-010A02  
010P07 white nautic

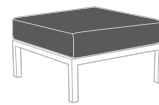

CPP-MARP07284P  
SET 1 cojín - almofada - cushion - coussin  
010P07 white nautic  
75x75x15cm



## MARINE TABLE

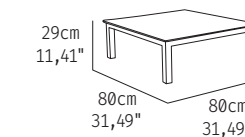

45K00C08000-010K00  
white compact



45K00C08000  
010K00 white compact  
80x80cm



Sofá individual. Aluminio lacado blanco. Anclaje para unión entre piezas. Cojines tejido Nautic\*.  
Sofá individual. Aluminio lacado branco. Fixador de união entre peças. Almofadas tecido Nautic\*.  
Single sofa. White lacquered aluminium. Locking system between pieces. Nautic\* fabric cushions.  
Canapé individuel. Aluminium laqué blanc. Éléments de fixation entre modules. Coussins toile Nautic\*.

Sofá esquinero. Aluminio lacado blanco. Anclaje para unión entre piezas. Cojines tejido Nautic\*.  
Sofá de canto. Aluminio lacado branco. Fixador de união entre peças. Almofadas tecido Nautic\*.  
Corner sofa. White lacquered aluminium. Locking system between pieces. Nautic\* fabric cushions.  
Canapé d'angle. Aluminium laqué blanc. Éléments de fixation entre modules. Coussins toile Nautic\*.

Sofá intermedio. Aluminio lacado blanco. Anclaje para unión entre piezas. Cojines tejido Nautic\*.  
Sofá intermédio. Aluminio lacado branco. Fixador de união entre peças. Almofadas tecido Nautic\*.  
In-between sofa. White lacquered aluminium. Locking system between pieces. Nautic\* fabric cushions.  
Canapé intermediaire. Aluminium laqué blanc. Éléments de fixation entre modules. Coussins toile Nautic\*.

Pouf. Aluminio lacado blanco. Anclaje para unión entre piezas. Cojín tejido Nautic\*.  
Pouf. Aluminio lacado branco. Fixador de união entre peças. Almofadas tecido Nautic\*.  
Pouf. White lacquered aluminium. Locking system between pieces. Nautic\* fabric cushions.  
Pouf. Aluminium laqué blanc. Éléments de fixation entre modules. Coussins toile Nautic\*.

Mesa aluminio lacado blanco. Anclaje para unión entre piezas. Tablero Compact 80x80.  
Mesa aluminio lacado branco. Fixador de união entre peças. Tampo Compact 80x80.  
White lacquered aluminium table. Locking system between pieces. 80x80 Compact table top.  
Table aluminium laqué blanc. Éléments de fixation entre modules. Plateau Compact 80x80.

\* NAUTIC - No utilizar productos abrasivos, Não utilizar produtos abrasivos, Do not use abrasive products, Ne pas utiliser de produit abrasif.



## SIENA MAXI MODULE METHACRYLATE

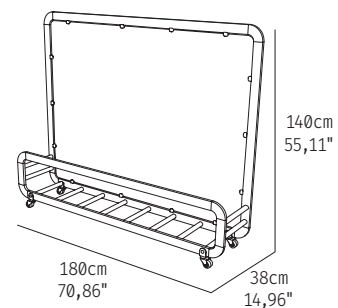

MO-MSIE05A  
anthracite



MO-MSIE05B  
white



MO-MSIE05T  
taupe

Módulo separador. Aluminio lacado y anodizado. Tornillería acero inox. 4 ruedas (2 con freno). Conexiones en poliamida con fibra de vidrio. Metacrilato transparente 5 mm - 0,19".

Módulo separador. Aluminio lacado e anodizado. Acessórios em aço inox. 4 rodas (2 com travão). Conexões em poliamida com fibra de vidro. Metacrilato transparente 5 mm - 0,19".

Divider module. Lacquered and anodized aluminium. Stainless steel hardware. 4 wheels (2 with brake). Polyamide with fiberglass connecting pieces. Transparent methacrylate 5 mm - 0,19".

Module séparateur. Aluminium laqué et anodisé. Visserie en acier inox. 4 roues (2 avec frein). Pièces de connection en polyamide avec fibre de verre. Méthacrylate transparent 5mm - 0,19".

+ INFO



## SIENA MAXI MODULE OLEFIN

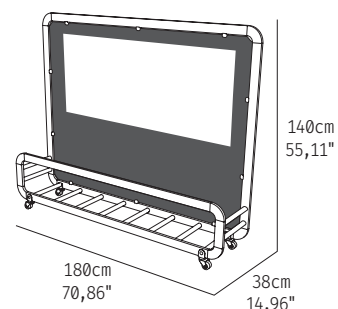

MO-V010SIE05A  
anthracite



MO-V010SIE051B  
white



MO-V010SIE05T  
taupe

Módulo separador. Aluminio lacado y anodizado. Tornillería acero inox. 4 ruedas (2 con freno). Conexiones en poliamida con fibra de vidrio. Tejido Olefin® con ventana.

Módulo separador. Aluminio lacado e anodizado. Acessórios em aço inox. 4 rodas (2 com travão). Conexões em poliamida com fibra de vidro. Tecido Olefin® com janela.

Divider module. Lacquered and anodized aluminium. Stainless steel hardware. 4 wheels (2 with brake). Polyamide with fiberglass connecting pieces. Olefin® fabric with window.

Module séparateur. Aluminium laqué et anodisé. Visserie en acier inox. 4 roues (2 avec frein). Pièces de connection en polyamide avec fibre de verre. Tissu Olefin® avec fenêtre.

+ INFO



## SIENA MAXI PANEL METHACRYLATE

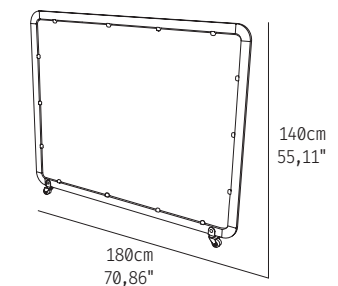

MO-MSIE03A  
anthracite



MO-MSIE03B  
white



MO-MSIE03T  
taupe

Panel separador. Aluminio lacado y anodizado. Tornillería acero inox. 2 ruedas con freno. Conexiones en poliamida con fibra de vidrio. Metacrilato transparente 5 mm - 0,19".

Painel separador. Aluminio lacado e anodizado. Acessórios em aço inox. 2 rodas com travão. Conexões em poliamida com fibra de vidro. Metacrilato transparente 5 mm - 0,19".

Divider Panel. Lacquered and anodized aluminium. Stainless steel hardware. 2 wheels with brake. Polyamide with fiberglass connecting pieces. Transparent methacrylate 5 mm - 0,19".

Panneau séparateur. Aluminium laqué et anodisé. Visserie en acier inox. 2 roues avec frein. Pièces de connection en polyamide avec fibre de verre. Méthacrylate transparent 5mm - 0,19".

+ INFO



## SIENA MAXI PANEL OLEFIN

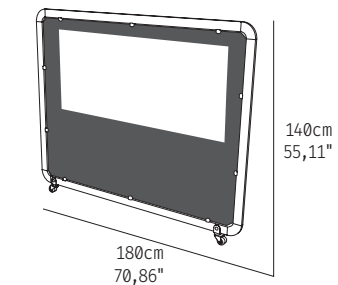

MO-V010SIE03A  
anthracite



MO-V010SIE031B  
white



MO-V010SIE03T  
taupe

Panel separador. Aluminio lacado y anodizado. Tornillería acero inox. 2 ruedas con freno. Conexiones en poliamida con fibra de vidrio. Tejido Olefin® con ventana.

Painel separador. Aluminio lacado e anodizado. Acessórios em aço inox. 2 rodas com travão. Conexões em poliamida com fibra de vidro. Tecido Olefin® com janela.

Divider Panel. Lacquered and anodized aluminium. Stainless steel hardware. 2 wheels with brake. Polyamide with fiberglass connecting pieces. Olefin® fabric with window.

Panneau séparateur. Aluminium laqué et anodisé. Visserie en acier inox. 2 roues avec frein. Pièces de connection en polyamide avec fibre de verre. Tissu Olefin® avec fenêtre.

+ INFO





## SIENA MINI MODULE/PANEL METHACRYLATE

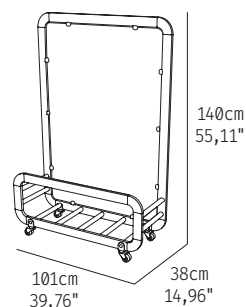

+ INFO



MO-MSIE06A  
anthracite



MO-MSIE04A  
anthracite



MO-MSIE062B  
white



MO-MSIE042B  
white



MO-MSIE06T  
taupe



MO-MSIE04T  
taupe

Módulo/panel separador. Aluminio lacado y anodizado. Tornillería acero inox. Módulo: 4 ruedas (2 con freno), Panel: 2 ruedas con freno. Conexiones en poliamida con fibra de vidrio. Metacrilato transparente 5 mm.

Módulo/panel separador. Alumínio lacado e anodizado. Acessórios em aço inox. Módulo: 4 rodas (2 com travão), Painel: 2 rodas com travão. Conexões em poliamida com fibra de vidro. Metacrilato transparente 5 mm.

Module/divider panel. Lacquered and anodized aluminium. Stainless steel hardware. Module: 4 wheels (2 with brake), Panel: 2 wheels with brake. Polyamide with fiberglass connecting pieces. Transparent methacrylate 5 mm.

Module/panneau séparateur. Aluminium laqué et anodisé. Visserie en acier inox. Module: 4 roues (2 avec frein), Panneau: 2 roues avec frein. Pièces de connection en polyamide avec fibre de verre. Méthacrylate transparent 5mm.

## SIENA MINI MODULE/PANEL OLEFIN

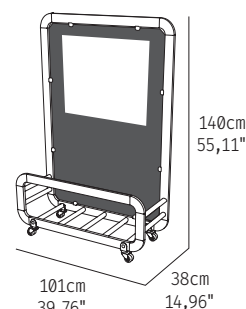

+ INFO



MO-V010SIE06A  
anthracite



MO-V010SIE04A  
anthracite



MO-V010SIE061B  
white



MO-V010SIE041B  
white



MO-V010SIE06T  
taupe



MO-V010SIE04T  
taupe

Módulo/panel separador. Aluminio lacado y anodizado. Tornillería acero inox. Módulo: 4 ruedas (2 con freno), Panel: 2 ruedas con freno. Conexiones en poliamida con fibra de vidrio. Tejido Olefin® con ventana.

Módulo/panel separador. Alumínio lacado e anodizado. Acessórios em aço inox. Módulo: 4 rodas (2 com travão), Painel: 2 rodas com travão. Conexões em poliamida com fibra de vidro. Tecido Olefin® com janela.

Module/divider panel. Lacquered and anodized aluminium. Stainless steel hardware. Module: 4 wheels (2 with brake), Panel: 2 wheels with brake. Polyamide with fiberglass connecting pieces. Olefin® fabric with window.

Module/panneau séparateur. Aluminium laqué et anodisé. Visserie en acier inox. Module: 4 roues (2 avec frein), Panneau: 2 roues avec frein. Pièces de connection en polyamide avec fibre de verre. Tissu Olefin® avec fenêtre.

## ACCESSORIES



MO-SIE52A  
anthracite



MO-SIE52B  
white



MO-SIE52T  
taupe

Pernio para pared  
Dobradiça para parede  
Wall fitting  
Joint flexible pour mur.



MO-JAR03  
black



MO-JAR04  
white

Jardinera  
Jardineira  
Flowerpot  
Jardinière

80x30x30 cm  
31,49x11,81x11,81"



MO-SIE53A  
anthracite



MO-SIE53B  
white



MO-SIE53T  
taupe

Pernio individual  
Dobradiça individual  
Individual fittings  
Joint flexible individuel





# EOLO PURETI

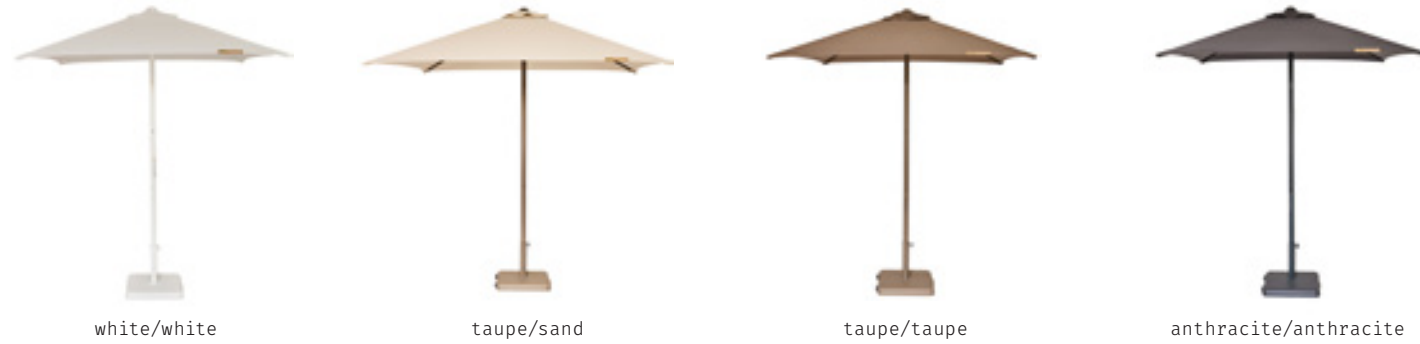

## Tamaños / Tamanhos / Sizes / Tailles

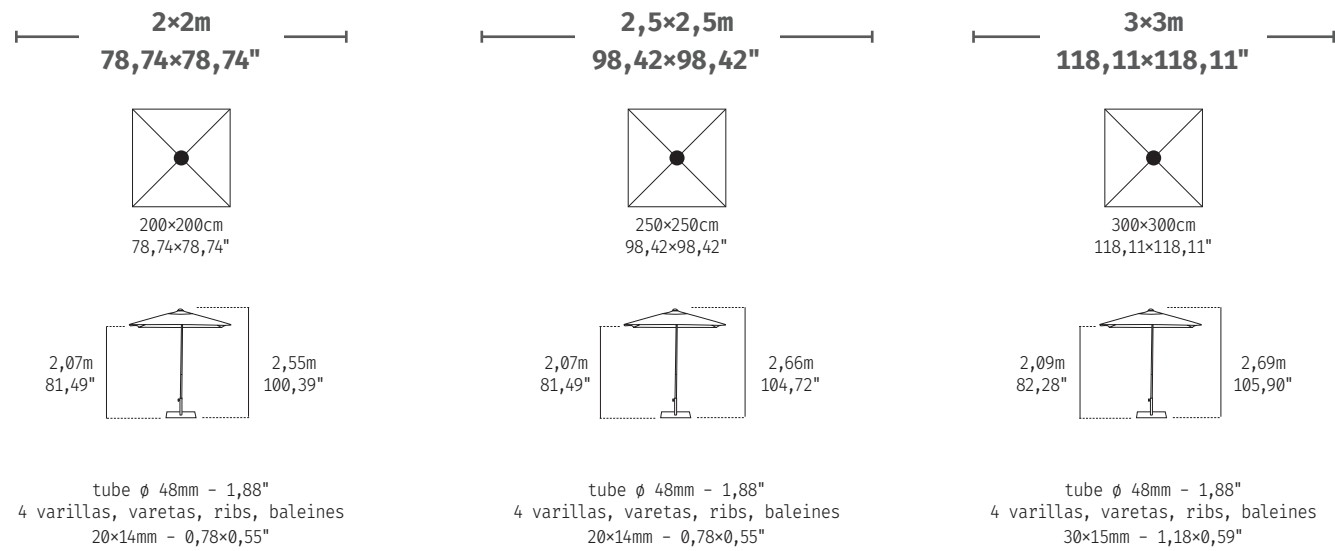

## Tejidos / Tecidos / Fabrics / Tissus

### Olefin



## Bases / Pieds (Pag. 188-191)

•CUBE •FIX •FASTCLICK •BONDø60 •LOOP •CANTOø60

## Referencias / Referências / References / Références

Color frame	2x2m - 78,74x78,74"	2,5x2,5m - 98,42x98,42"	3x3m - 118,11x118,11"
white	SPA010C2002721P	SIA010C2502720P	SGA010C3002720P
taupe	SPA010C2002821P	SIA010C2502820P	SGA010C3002820P
anthracite	SPA010C2002621P	SIA010C2502620P	SGA010C3002620P



Parasol de aluminio lacado con 4 varillas. Apertura tipo push-up con sistema abre/cierra y pulsador de bloqueo. Sin volante y con fugavientos.

Guarda-sol em alumínio lacado com 4 varetas. Abertura tipo push-up com sistema abre/fecha e botão de bloqueio. Sem babinela e com fugavientos.

Lacquered aluminum parasol with 4 ribs. Easy push-up open system with an open-lock handle. Without valance and with airvent.

Parasol aluminium laqué avec 4 baleines. Ouverture push-up avec système d'ouverture / fermeture et verrouillage. Sans volant et avec soufflet.

Registered design No. 007003710 - Utility model No. 201931894



## EL PARASOL QUE PURIFICA EL AIRE - O GUARDA-SOL QUE PURIFICA O AR THE PARASOL THAT PURIFIES THE AIR - LE PARASOL QUI PURIFIE L'AIR

pureti



Al igual que los árboles, el tejido de este parasol descontamina el aire de las ciudades, neutraliza los gases de los motores y otras sustancias nocivas. Incorpora una nanotecnología que, en contacto con la luz solar, convierte las sustancias contaminantes del aire en sales inertes.

Tal como as árvores, o tecido deste guarda-sol descontamina o ar das cidades, neutraliza os gases dos motores e outras substâncias nocivas. Tem incorporada uma nanotecnologia que, em contacto com a luz solar, converte as substâncias contaminantes do ar em sais inertes.

Much like trees, the fabric of this umbrella reduces city pollution, neutralizing engine gases and other harmful substances. Its nanotechnology, upon contact with sunlight, turns air pollutants into inert salts.

Tout comme les arbres, le tissu de ce parasol décontamine l'air des villes et neutralise les gaz d'échappement des moteurs et d'autres substances nocives. Il intègre une nanotechnologie qui, en contact avec la lumière du soleil, transforme les substances contaminantes de l'air en sels inertes.



# EOLO



white

taupe

anthracite

## Tamaños / Tamanhos / Sizes / Tailles

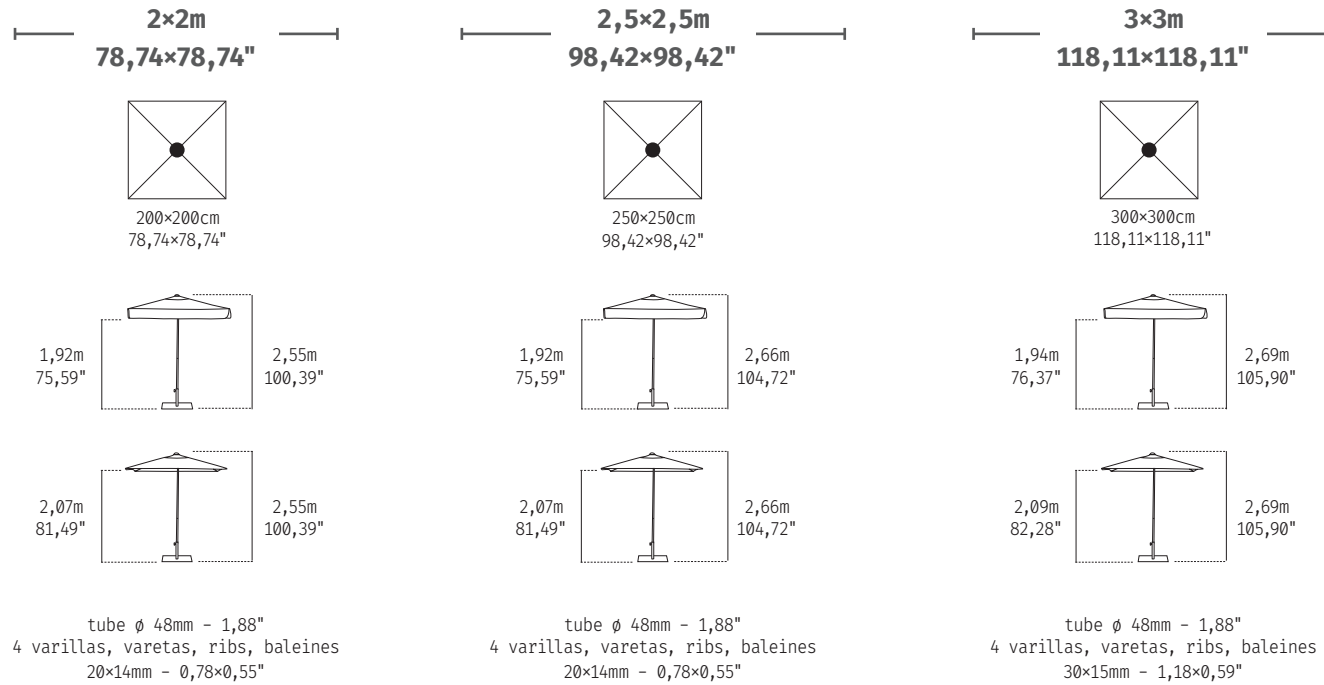

## Tejidos / Tecidos / Fabrics / Tissus

### Olefin



112010\* white, 103010\* sand, 101010\* taupe, 110010\* anthracite, 102010 black



109010 moka, 121010 olivo, 123010 ice, 122010 sky blue, 117010 navy



115010 taupe stripe, 116010 anthracite stripe, 125010 blue stripe, 124010 green stripe

### Sumbrella

NEW



400D24 marble, 401D24 mineral blue, 405D24 mint

## Bases / Pieds (Pag. 188-191)

•CUBE •FIX •FASTCLICK •BONDø60 •LOOP •CANTOø60



Parasol de aluminio lacado con 4 varillas. Apertura tipo push-up con sistema abre/cierra y pulsador de bloqueo. Sin volante y con fugavientos.

Guarda-sol em alumínio lacado com 4 varetas. Abertura tipo push-up com sistema abre/fecha e botão de bloqueio. Sem babinela e com fugavientos.

Lacquered aluminum parasol with 4 ribs. Easy push-up open system with an open-lock handle. Without valance and with airvent.

Parasol aluminium laqué avec 4 baleines. Ouverture push-up avec système d'ouverture / fermeture et verrouillage. Sans volant et avec soufflet.

Registered design No. 007003710 - Utility model No. 201931894



+ INFO



## Referencias / Referências / References / Références

	Color frame	2x2m - 78,74x78,74"	2,5x2,5m - 98,42x98,42"	3x3m - 118,11x118,11"
	white	SPA010C2002740P	SIA010C2502740P	SGA010C3002740P
	taupe	SPA010C2002840P	SIA010C2502840P	SGA010C3002840P
	anthracite	SPA010C2002640P	SIA010C2502640P	SGA010C3002640P
	white	SPA010C2002720P	SIA010C2502721P	SGA010C3002721P
	taupe	SPA010C2002820P	SIA010C2502821P	SGA010C3002821P
	anthracite	SPA010C2002620P	SIA010C2502621P	SGA010C3002621P
	white	SPAD24C2002770P	SIAD24C2502771P	SGAD34C3002771P
	taupe	SPAD24C2002870P	SIAD24C2502871P	SGAD34C3002871P
	anthracite	SPAD24C2002670P	SIAD24C2502671P	SGAD34C3002671P

\* Los parasoles white/white, taupe/taupe, taupe/sand y antracita/antracita son Pureti - Os guarda sois branco/branco, taupe/taupe, taupe/sande Antracita/Antracita são - Parasols white/white, taupe/taupe, taupe/sand and anthracite/anthracite are Pureti - Les parasols blanc/blanc, taupe/taupe, taupe/sand et Antracite/anthracite sont Pureti



# FLEXO 3x3m - 118,11x118,11"



white

taupe

anthracite

## Tamaños / Tamanhos / Sizes / Tailles

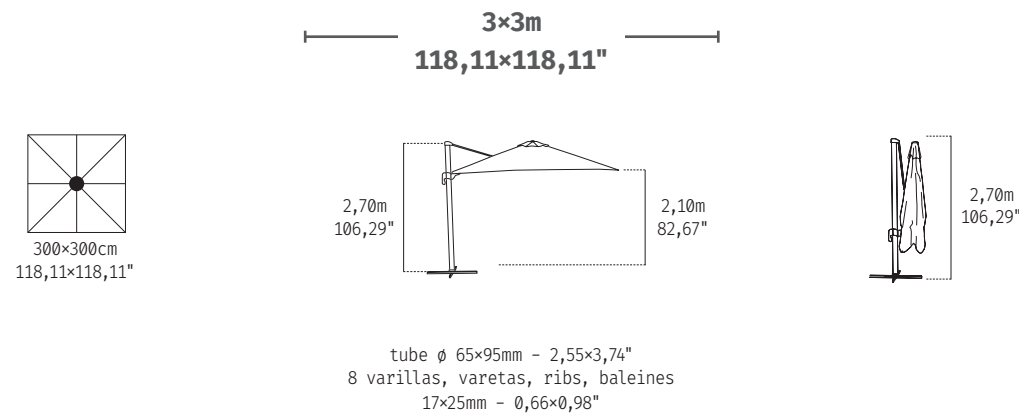

## Tejidos / Tecidos / Fabrics / Tissus

### Olefin



## Bases / Pieds (Pag. 188-191)

•SLAB •KITFLEXO

## Referencias / Referências / References / Références

Color frame	3x3m - 118,11x118,11"
white	SGA010C3005021P
taupe	SGA010C3005022P
anthracite	SGA010C3005020P



Sistema estabilizador. Stabilizer system. Système stabilisateur.

Parasol de aluminio de mastil lateral con inclinación. 8 varillas. Giratorio 360°. Sistema estabilizador. Sin volante y con fugavientos.  
Guarda-sol em alumínio de haste lateral com inclinação. 8 varetas. Giratório 360°. Sistema estabilizador. Sem banelina e com fugavientos.  
Aluminium lateral pole parasol with tilt system. 8 ribs. 360° rotatory system. Stabilizer system. Without valance and with airvent.  
Parasol mât latéral avec inclinaison. 8 baleines. Rotatif 360°. Système stabilisateur. Sans volant et avec soufflet.

(Cruceta incluida / cruzeta incluida / cross included / croix incluse)

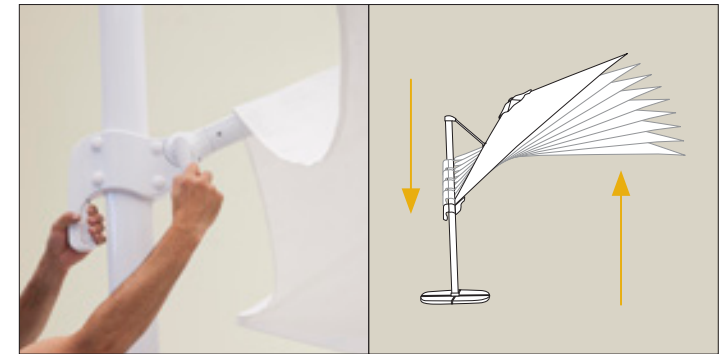

Tela multiposición. Tecido multiposições. Multi-position fabric. Tissu multipositions.

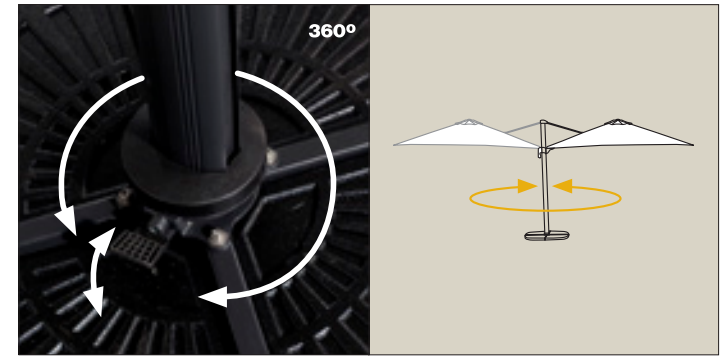

Sistema de rotación. Sistema de rotação. Rotation System. Système de rotation.



Usar con estas bases. Utilizar com estas bases. Use with these bases. A utiliser avec ces bases:

**SLAB**  
o  
**KIT FLEXO**

✓ Sistema de rotación. Sistema de rotação. Rotation System. Système de rotation.

✓ Más espacio debajo. Mais espaço em baixo. More space below. Plus d'espace ci-dessous.

✗ Ruedas. Rodas. Wheels. Roues.

✗ Sistema de rotación. Sistema de rotação. Rotation System. Système de rotation.

✓ Más espacio debajo. Mais espaço em baixo. More space below. Plus d'espace ci-dessous.

✓ Ruedas. Rodas. Wheels. Roues.



# RIO 4x4m - 157,48x157,48"



white



anthracite

## Tamaños / Tamanhos / Sizes / Tailles

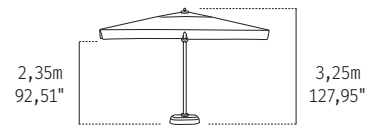
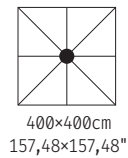
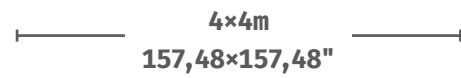

3,25m  
127,95"

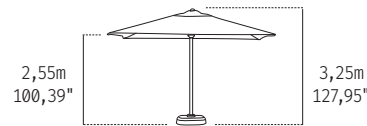

3,25m  
127,95"

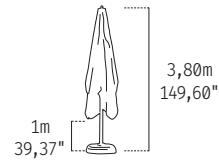

telescopic

tube  $\phi$  71x71mm - 2,79x2,79"  
8 varillas, varetas, ribs, baleines  
20x35x1,5mm - 0,78x1,37x0,05"

## Tejidos / Tecidos / Fabrics / Tissus

### Olefin 250g



212020  
white



203020  
sand



201020  
taupe



210020  
anthracite



202020  
black

## Bases / Pieds (Pag. 188-191)

•KIT CROSSRIO •FIXRIO •FAST CLICKRIO

## Referencias / Referências / References / Références



olefin



olefin

Color frame	4x4m - 157,48x157,48"
white	SGA020C4000240P
anthracite	SGA020C4000440P
white	SGA020C4000220P
anthracite	SGA020C4000420P



Parasol de aluminio lacado para terrazas grandes. 8 varillas intercambiables. Apertura asistida manivela. Telescópico. Con o sin volante y con fugavientos.

Guarda-sol em alumínio lacado para esplanadas grandes. 8 varetas intercambiáveis. Abertura assistida manivela. Telescópico. Com ou sem babinela e com fugavientos.

Lacquered aluminium parasol for big terraces. 8 exchangeable ribs. Crank-assisted opening system. Telescopic. With or without valance and with airvent.

Parasol aluminium laqué pour grande terrasse. 8 baleines interchangeables. Ouverture assistée manivelle. Télescopique. Avec ou sans volant et avec soufflet.





# FORMENTERA



## Tamaños / Tamanhos / Sizes / Tailles

3x3m  
118,11x118,11"

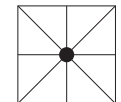

300x300cm  
118,11x118,11"

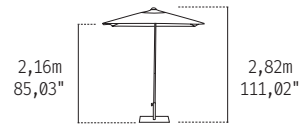
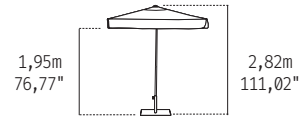

tube ø 50mm - 1,96"  
8 varillas, varetas, ribs, baleines  
30x20mm - 1,18x0,78"

3,5x3,5m  
137,79x137,79"

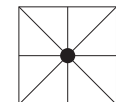

350x350cm  
137,79x137,79"

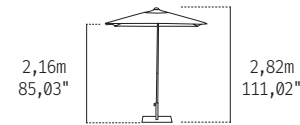
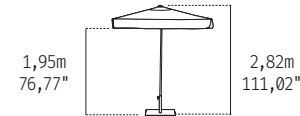

tube ø 50mm - 1,96"  
8 varillas, varetas, ribs, baleines  
30x20mm - 1,18x0,78"

## Tejidos / Tecidos / Fabrics / Tissus

### Olefin



112010  
white



103010  
sand



101010  
taupe



110010  
anthracite



102010  
black



109010  
moka



121010  
olivo



123010  
ice



122010  
sky blue



117010  
navy



115010  
taupe  
stripe



116010  
anthracite  
stripe



125010  
blue  
stripe



124010  
green  
stripe

## Bases / Pieds (Pag. 188-191)

•KIT CROSS(3,5x3,5) •CUBE •FIX •FAST CLICK •BONDø60 (3x3) •LOOP •CANTOø60



Parasol de aluminio lacado. 8 varillas. Apertura por poleas. Sin volante y con fugavientos.

Guarda-sol em alumínio lacado. 8 varetas. Abertura por roldanas. Sem bambinela e com fugaventos.

Lacquered aluminium parasol. 8 ribs. Pulley opening system. Without valance and with airvent.

Parasol aluminium laqué. 8 baleines. Ouverture par poulie. Sans volant et avec soufflet.

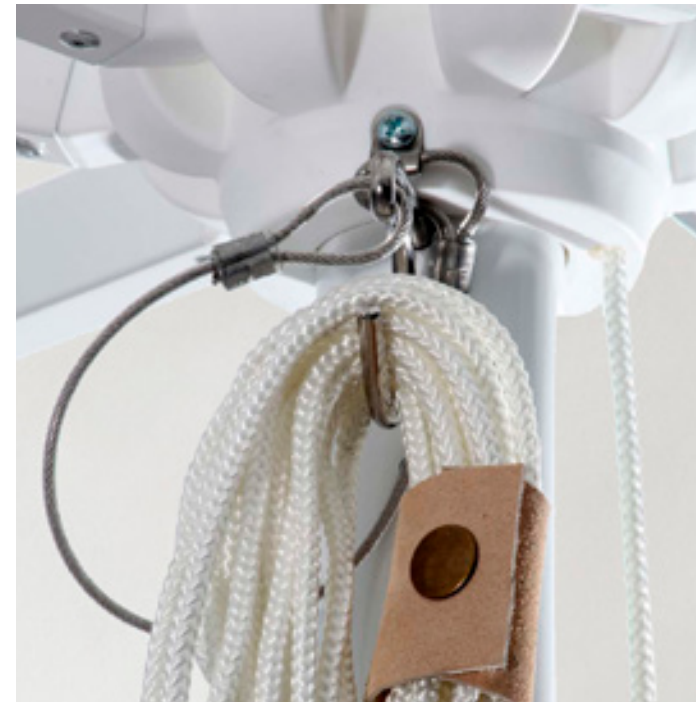
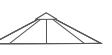

## Referencias / Referências / References / Références

Color frame	3x3m - 118,11x118,11"	3,5x3,5m - 137,79x137,79"
white	SGA010C3000240P	SGA010C3500140P
anthracite	SGA010C3000540P	SGA010C3500340P
white	SGA010C3000220P	SGA010C3500120P
anthracite	SGA010C3000520P	SGA010C3500320P





# FORMENTERA LATERAL

**NEW**



anthracite

## Tamaños / Tamanhos / Sizes / Tailles

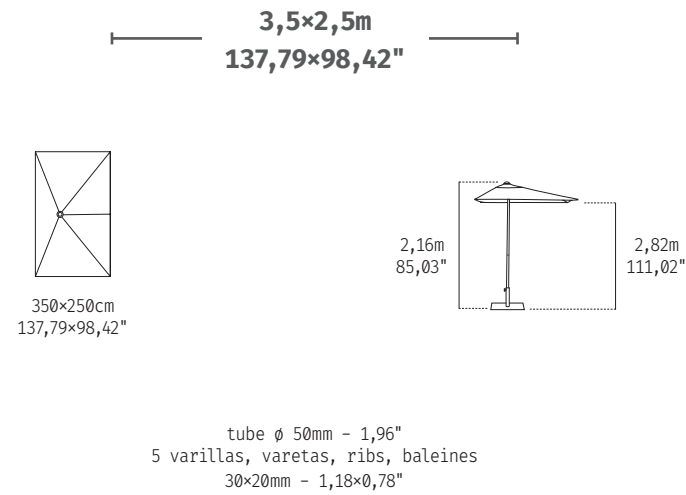

## Tejidos / Tecidos / Fabrics / Tissus



### Olefin



## Bases / Pieds (Pag. 188-191)

•CANTOø60

## Referencias / Referências / References / Références

	<b>Color frame</b>	<b>3,5x2,5m - 137,79x98,42"</b>
	 anthracite	SGA010H3500020P

Parasol de aluminio lacado de mástil lateral. 5 varillas. Apertura por poleas. Sin volante y con fugavientos.

Guarda-sol de mastro lateral em alumínio lacado. 5 varetas. Abertura por roldanas. Sem bambinela e com fugaventos.

Lacquered aluminum side mast parasol. 5 ribs. Pulley opening system. Without valance and with airvent.

Parasol latéral en aluminium laqué. 5 baleines. Ouverture par poulie. Sans volant et avec soufflet.







grey

Tamaños / Tamanhos / Sizes / Tailles

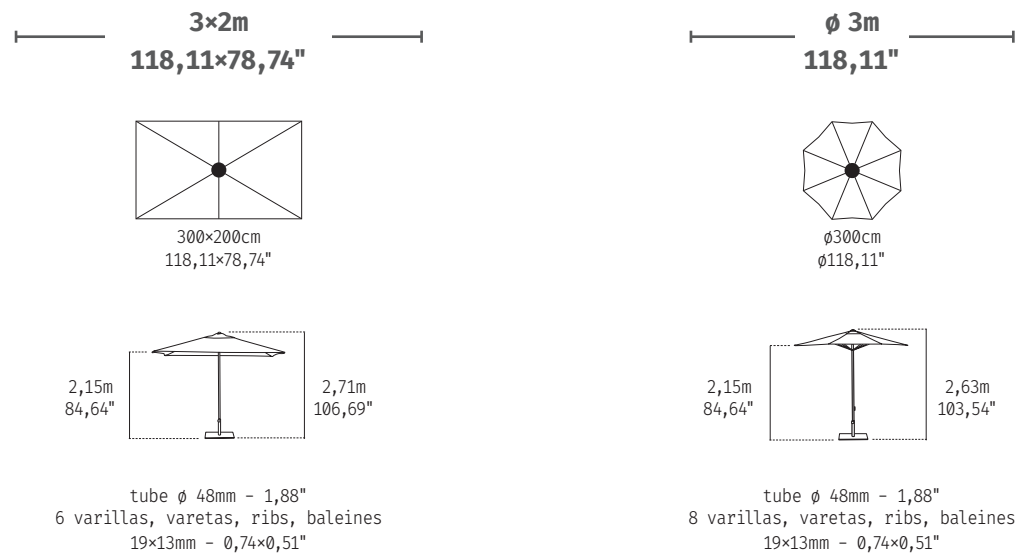

Tejidos / Tecidos / Fabrics / Tissus

Olefin



Bases / Pieds (Pag. 188-191)

- CUBE •FIX •FASTCLICK •BOND $\phi$ 60 •LOOP •CANTO $\phi$ 60

Referencias / Referências / References / Références

Color frame	3x2m - 118,11x78,74"	$\phi$ 3m - 118,11"
grey	SGA010H3000020P	SIA010030000820P



Parasol de aluminio lacado gris. 8 varillas. Apertura por poleas. Sin volante y con fugavientos.

Guarda-sol em alumínio lacado cinza. 8 varetas. Abertura por roldanas. Sem bambinela e com fugaventos.

Grey lacquered aluminium parasol. 8 ribs. Pulley opening system. Without valance and with airvent.

Parasol aluminium laqué gris. 8 baleines. Ouverture par poulie. Sans volant et avec soufflet.





# JAVA



## Tamaños / Tamanhos / Sizes / Tailles

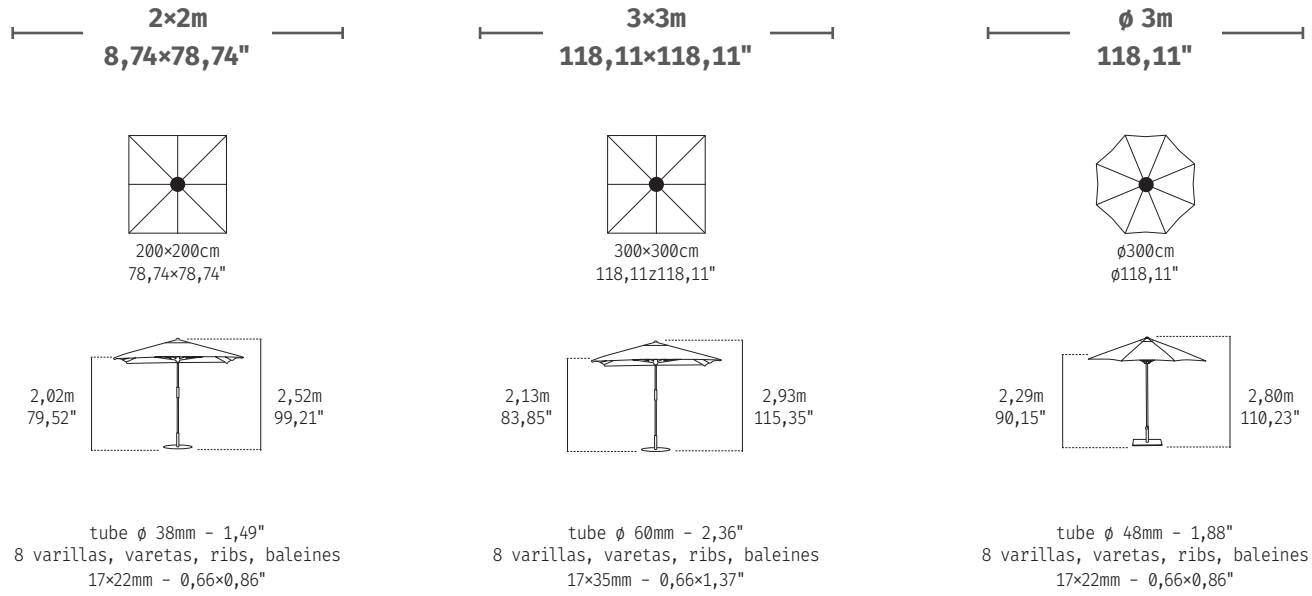

## Tejidos / Tecidos / Fabrics / Tissus

### Olefin



## Bases / Pieds (Pag. 188-191)

• CUBE (2x2-Ø3) • FIX (Ø3) • FAST CLICK (Ø3) • BOND Ø60 (2x2-Ø3) • LOOP (2x2-Ø3) • CANTO Ø60 (2x2-Ø3) • CANTO Ø70 (3x3)

## Referencias / Referências / References / Références

Color frame	2x2m - 78,74x78,74"	3x3m - 118,11x118,11"	Ø 3m - 118,11"
wood	SPM010C2000220P	SGM010C3000220P	SIM01003000720P



Parasol de madera de eucalipto barnizada. 8 varillas. Apertura por poleas. Sin volante y con fugavientos. Madera procedentes de fuentes sostenibles. Certificado FSC®.

Guarda-sol de madeira de eucalipto envernizada. 8 varetas. Abertura por roldanas. Sem bambinela e com fugavientos. Madeira proveniente de fontes reflorestadas. Certificado FSC®.

Varnished eucalyptus wood parasol. 8 ribs. Pulley opening system. Without valance and with airvent. Wood from reforested sources. FSC® certified.

Parasol bois d'eucalyptus verni. 8 baleines. Ouverture par poulie. Sans volant et avec soufflet. Bois provenant de sources reboisées. Certified FSC®.

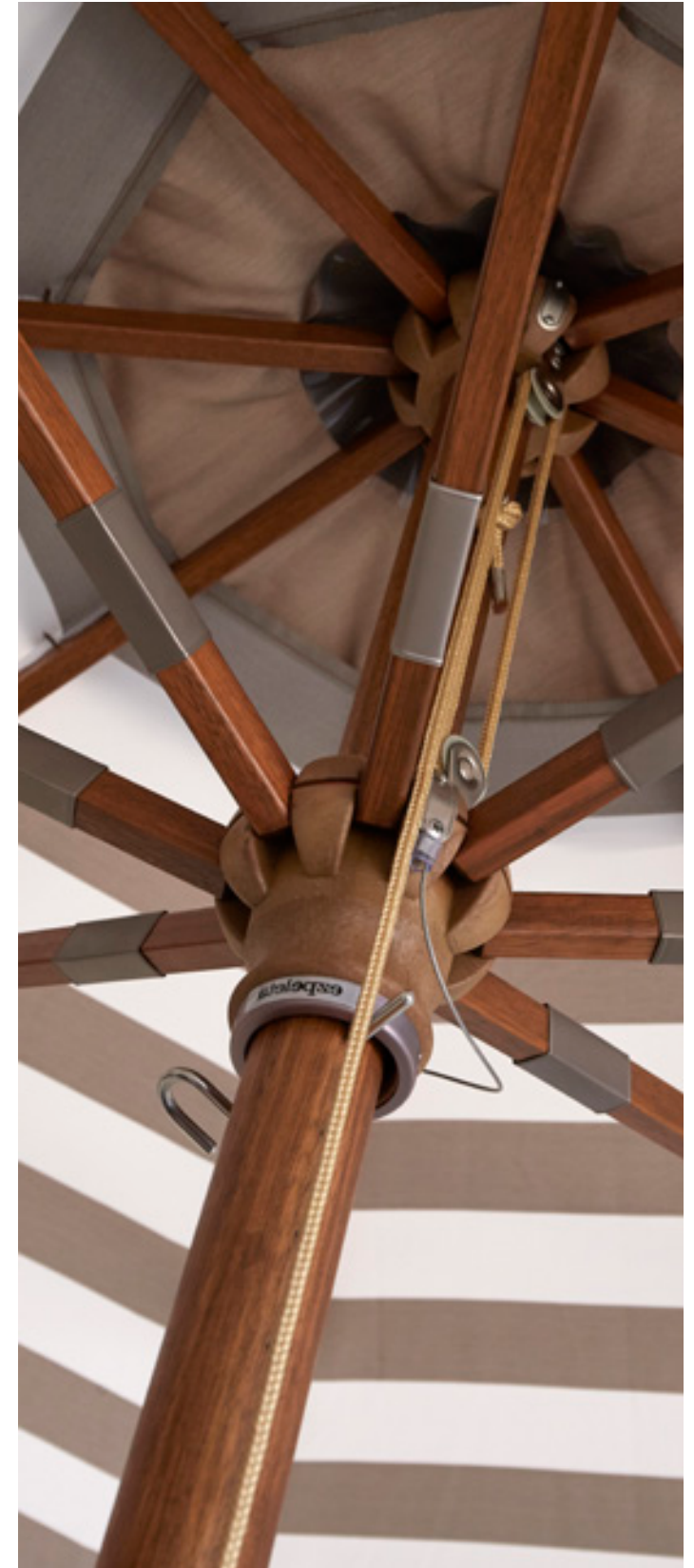



## MADEIRA 3m - 118,11"

SIM01003000750P

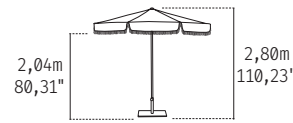
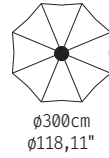

tube Ø 48mm - 1,88"  
8 varillas, varetas, ribs, baleines  
17x22mm - 0,66x0,86"

### Olefin



Parasol de madera de eucalipto barnizada. 8 varillas. Apertura por poleas. Con volante, fleco y fugavientos. Madera procedente de fuentes sostenibles. *Certificado FSC®.*  
*Guarda-sol de madeira de eucalipto envernizada. 8 varetas. Abertura por roldanas. Com bambinela, franjas e fugavientos. Madeira proveniente de fontes reflorestadas. Certificado FSC®.*  
Varnished eucalyptus wood parasol. 8 ribs. Pulley opening system. With valance, fringes and airvent. Wood from reforested sources. FSC® certified.



*Parasol bois d'eucalyptus verni. 8 baleines. Ouverture par poulie. Avec volants, franges et soufflet. Bois provenant de sources robisées. Certified FSC®.*

### Bases / Pieds (Pag. 188-191)

- CUBE
- FIX
- FAST CLICK
- BOND Ø60
- LOOP
- CANTO Ø60

## PALMA GREY 2,5m - 98,42"

SIA01002500000P

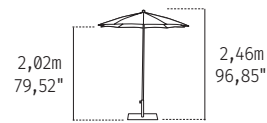
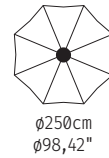

tube Ø 40-45mm - 1,57-1,77"  
8 varillas, varetas, ribs, baleines  
8mm - 0,31"

### Olefin

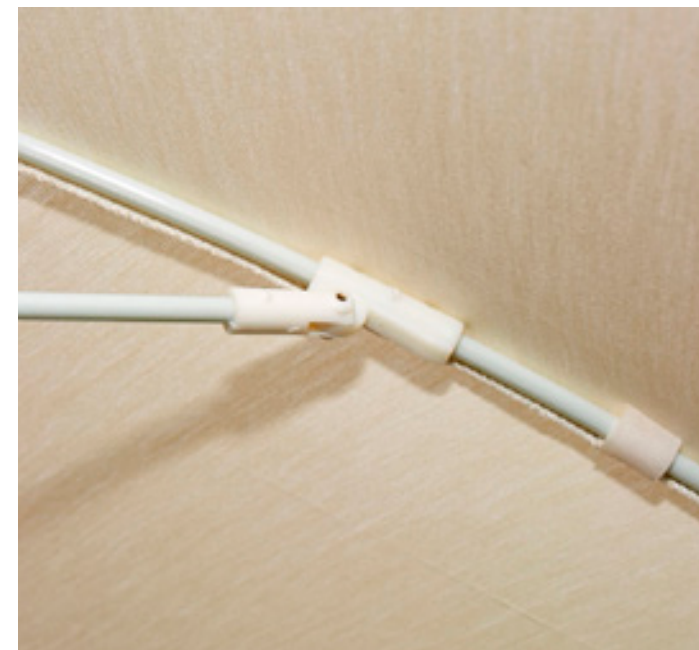
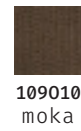

Parasol de aluminio. 8 varillas de fibra de vidrio. Regulable en altura. Sin volante y sin fugavientos. Capito T extrarresistente. *Guarda-sol em alumínio. 8 varetas de fibra de vidro. Regulável em altura. Sem bambinela e sem fugavientos. Tip T extraforte.*  
Aluminium parasol. 8 fiberglass ribs. Adjustable height. Without valance and without airvent. Extrarresistant T tip. *Parasol aluminium. 8 baleines en fibre de verre. Ajustable en hauteur. Sans volant et sans soufflet. Tip T extra forte.*



### Bases / Pieds (Pag. 188-191)

- BOND Ø60
- LOOP

## MENORCA 2,5m - 98,42"

SIA01002500006P

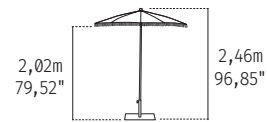
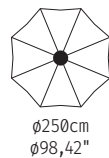

tube Ø 40-45mm - 1,57-1,77"  
8 varillas, varetas, ribs, baleines  
8mm - 0,31"

### Olefin



Parasol de aluminio. 8 varillas de fibra de vidrio. Regulable en altura. Sin volante y sin fugavientos. Con flecos. Capito T extrarresistente. *Guarda-sol em alumínio. 8 varetas de fibra de vidro. Regulável em altura. Sem bambinela e sem fugavientos. Com franjas. Tip T extraforte.*  
Aluminium parasol. 8 fiberglass ribs. Adjustable height. Without valance and without airvent. Whit fringes. Extrarresistant T tip. *Parasol aluminium. 8 baleines en fibre de verre. Ajustable en hauteur. Sans volant et sans soufflet. Avec franges. Tip T extra forte.*



### Bases / Pieds (Pag. 188-191)

- BOND Ø60
- LOOP



## TENERIFE INOX 2m - 78,74"

SPI010D2005310P

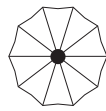

∅200cm  
∅78,74"

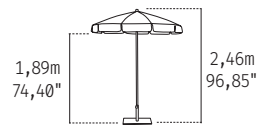

1,89m  
74,40"      2,46m  
96,85"

tube ∅ 28-35mm - 1,10-1,37"  
10 varillas, varetas, ribs, baleines  
6mm - 0,23"

### Olefin

112010 white	103010 sand	101010 taupe	110010 anthracite	102010 black
109010 moka	121010 olivo	123010 ice	122010 sky blue	117010 navy
115010 taupe stripe	116010 anthracite stripe	125010 blue stripe	124010 green stripe	



Parasol de INOX con inclinación. 10 varillas de fibra de vidrio. Regulable en altura. Con volante y sin fugavientos. Capito T extrarresistente.

Guarda-sol em INOX com inclinação. 10 varetas de fibra de vidro. Regulável em altura. Com bambelina e sem fugavientos. Tip T extraforte.

INOX parasol with tilt system. 10 fiberglass ribs. Adjustable height. With valance and without airvent. Extrarresistant T tip.

Parasol INOX avec inclinaison. 10 baleines en fibre de verre. Ajustable en hauteur. Avec volants et sans soufflet. Tip T extra forte.



OLEFIN  
FIBER  
190g

INOX

### Bases / Pieds (Pag. 188-191)

- BOND ∅45
- FIT ∅45

## ONS SAND 2m - 78,74"

SPA010D2000110T

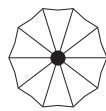

∅200cm  
∅78,74"

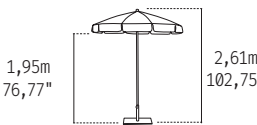

1,95m  
76,77"      2,61m  
102,75"

tube ∅ 29-32mm - 1,14-1,25"  
10 varillas, varetas, ribs, baleines  
6mm - 0,23"

### Olefin

112010 white	103010 sand	101010 taupe	110010 anthracite	102010 black
109010 moka	121010 olivo	123010 ice	122010 sky blue	117010 navy
115010 taupe stripe	116010 anthracite stripe	125010 blue stripe	124010 green stripe	



Parasol de aluminio lacado sand. 10 varillas de fibra de vidrio. Regulable en altura. Con volante y sin fugavientos. Capito T extrarresistente.

Guarda-sol em alumínio lacado sand. 10 varetas de fibra de vidro. Regulável em altura. Com bambelina e sem fugavientos. Tip T extraforte.

Sand lacquered aluminium parasol. 10 fiberglass ribs. Adjustable height. With valance and without airvent. Extrarresistant T tip.

Parasol aluminium laqué sand. 10 baleines en fibre de verre. Ajustable en hauteur. Avec volants et sans soufflet. Tip T extra forte.



OLEFIN  
FIBER  
190g

### Bases / Pieds (Pag. 188-191)

- BOND ∅45
- FIT ∅40



## NEW TOSCANA

SPA010D2000150T

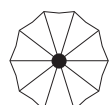

ø200cm  
ø78,74"



1,89m  
74,40" 2,61m  
102,75"

tube ø 29-32mm - 1,14-1,25"  
10 varillas, varetas, ribs, baleines  
6mm - 0,23"

Olefin



0011010  
olivo/sand



0012010  
sky blue/sand



103010  
sand/sand



Parasol de aluminio lacado sand. 10 varillas de fibra de vidrio. Regulable en altura. Con flecos. Con volante y sin fugavientos. Capito T extrarresistente.

Guarda-sol em alumínio lacado sand. 10 varetas de fibra de vidro. Regulável em altura. Com franjas. Com bambelina e sem fugavientos. Tip T extraforte.

Sand lacquered aluminium parasol. 10 fiberglass ribs. Adjustable height. With fringes. With valance and without airvent. Extrarresistant T tip.

Parasol aluminium laqué sand. 10 baleines en fibre de verre. Ajustable en hauteur. Avec franges et volants et sans soufflet. Tip T extra forte.



OLEFIN  
FIBER  
190g

Bases / Pieds (Pag. 188-191)

- BONDø45
- FITø40

## MANILA NATURAL 2m - 78,74"

SPSZ02D2000001T

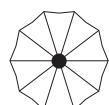

ø200cm  
ø78,74"



1,89m  
74,40" 2,61m  
102,75"

tube ø 29-32mm - 1,14-1,25"  
10 varillas, varetas, ribs, baleines  
6mm - 0,23"



Parasol de acero imitación madera natural. 10 varillas de fibra de vidrio. Regulable en altura. Con volante y sin fugavientos.

Guarda-sol em aço imitação madeira natural. 10 varetas de fibra de vidro. Regulável em altura. Com bambelina e sem fugavientos.

Natural wood finishing steel parasol. 10 fiberglass ribs. Adjustable height. With valance and without airvent.

Parasol acier finition bois naturel. 10 baleines en fibre de verre. Ajustable en hauteur. Avec volants et sans soufflet.



UPF50+

Bases / Pieds (Pag. 188-191)

- BONDø45
- FITø40

## FUNDA PARASOL - CAPA GUARDA-SOL - PARASOL COVER - COUVERTURE PARASOL



REF. 31P18C40000

RIO 400X4000

REF. 31P18C30000

FORMENTERA 300X300  
VIGO 300X300 - JAVA 300X300

REF. 31P18C35000

FORMENTERA 350X350  
FLEXO 300X300

REF. 31P18C25000

EOLO - VIGO - JAVA

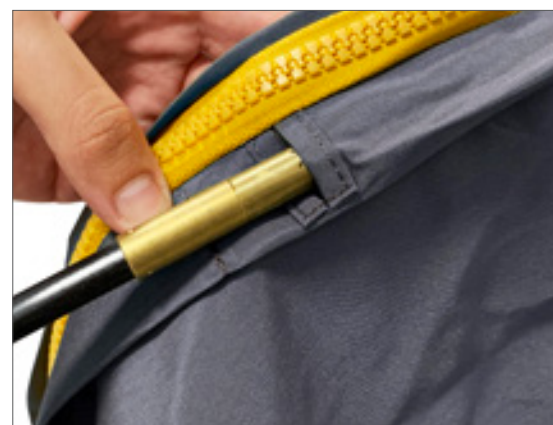

POLYESTER  
210g

WATER PROOF

+ INFO





## SUNBRELLA

Tejido exclusivamente con fibras acrílicas teñidas en masa desde el núcleo del mismo hilo para garantizar su resistencia a la decoloración frente a los rayos UV. Acabado repelente al agua, resistente al moho y antimanchas que protege el tejido y hace que su mantenimiento sea muy sencillo.

Garantía de 5 años frente a la abrasión, la aparición de bolitas, la decoloración y la pérdida de tensión.

Cuenta con el Sello de Recomendación de la Skin Cancer Foundation (Fundación contra el Cáncer de la Piel) que garantiza la protección de la piel de los efectos nocivos de los rayos UV.

*Tecido exclusivamente com fibras acrílicas tingidas em massa a partir do núcleo do próprio fio para garantir a sua resistência à descoloração contra os raios UV. O acabamento repelente à água, ao mofo e às manchas protege o tecido e facilita a sua manutenção.*

*5 anos de garantia contra abrasão, borboto, descoloração e perda de tensão.*

*Com o Selo de Recomendação da "Skin Cancer Foundation" que garante a proteção da pele contra os efeitos nocivos dos raios UV.*

The fabric is exclusively crafted from acrylic fibers, dyed thoroughly within the core of the yarn to ensure resistance against UV-induced fading. It is water-repellent, mold-resistant, and stain-repellent finish safeguards the fabric, simplifying maintenance.

It is backed by a 5-year warranty against abrasion, pilling, fading, and tension loss.

Endorsed by the Skin Cancer Foundation Seal, guaranteeing protection against the harmful effects of UV rays on the skin.

*Tissu exclusivement en fibres acryliques teinté à la masse depuis son processus initial, afin de garantir une haute résistance à la décoloration due aux rayons UV. Toile déperlante, résistante aux moisissures, anti-tâches qui facilite ainsi son entretien.*

*Toile garantie 5 ans, contre l'abrasion, les bouloches, décoloration et pertes de tension.*

*Certifiée est recommandée par la "SKIN CANCER FOUNDATION" qui garantit la protection de la peau aux effets nocifs des rayons UV.*

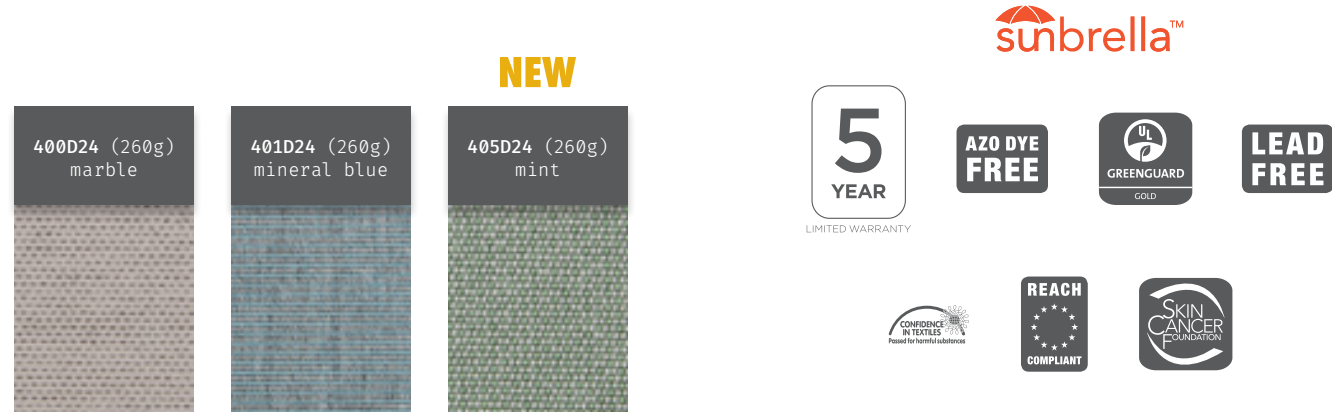

## NEW NAUTIC (Ibiza & Nana colchón/colchão/mattress/matelas)

Tejido repelente al agua, confeccionado en PCV y polyester. Gran resistencia a los rayos UV (Solidez a la luz >7). Antibacteriano y antimoho. Certificado BLUEWORLD.

*Tecido repelente à água, fabricado em PCV e poliéster. Elevada resistência aos raios UV (solidez à luz >7). Anti-bacteriano e anti-bolor. Certificado BLUEWORLD.*

Water repellent fabric, made of PCV and polyester. High UV resistance (Light fastness >7). Antibacterial and anti-mould. BLUEWORLD certified.

Tissu hydrofugé, composé de PCV et de polyester. Grande résistance aux rayons UV (solidité à la lumière >7). Anti-bactérien et anti-moisissure. Certifié BLUEWORLD.

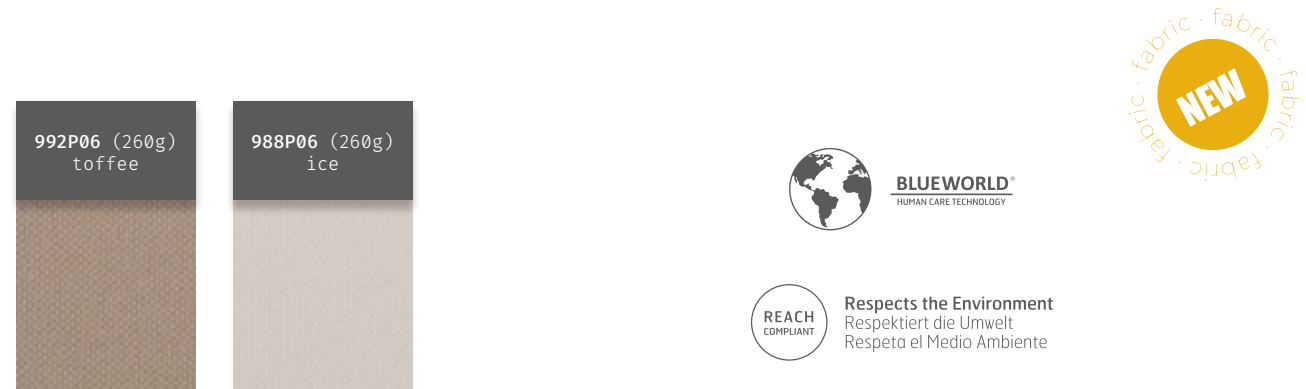

## OLEFIN

Alta solidez de los colores a la radiación UV (7/8). Se trata de un tejido fabricado con hilo de polipropileno que ha sido tintado en masa, en su proceso inicial. Esto le otorga una gran resistencia a la luz solar ya que el color queda fijado en el hilo del tejido con mayor intensidad que en otros procesos. Dependiendo del color varía la durabilidad de la intensidad de los colores a la exposición solar.

Certificación UV standard 801 con la puntuación UPF 80, que garantiza la protección de la piel de los efectos nocivos de los rayos UV.

Resistente a las manchas - 100% reciclable.

*Alta resistência das cores face à radiação UV. Ao ser um tecido fabricado com fio de polipropileno tingido em massa no seu processo inicial, esta característica confere-lhe uma maior resistência à luz solar o que se deve essencialmente ao facto de a cor permanecer fixa ao fio com maior intensidade do que em outros processos de pigmentação. A durabilidade da intensidade das cores, varia dependendo da cor e da exposição solar.*

*Certificação UV standard 801 com factor de proteção UPF 80, que garante a proteção da pele dos efeitos nocivos dos raios UV.*

*Anti-manchas - 100% reciclável.*

High resistance of colours to UV radiation (7/8). The fabric is made from polypropylene fabric mass-dyed during the initial process. This provides high resistance to sunlight because the colour is set in the thread of the fabric more intensely than in other processes. Depending on the color, the durability of color intensity varies when exposed to sunlight.

UV standard 801 certification rating UPF 80, that guarantees skin protection against nocive effects of UV rays on the skin.

Stain resistance - 100% recyclable.

*Haute résistance des couleurs face à la radiation solaire. Il s'agit ici d'une toile fabriquée à partir d'un fil en polypropylène qui a été teinté en masse, depuis son processus initial. Ceci lui confère une haute résistance à la lumière solaire, étant donné que la teinte reste fixée sur le fil avec une plus grande intensité en comparaison avec d'autres processus de pigmentation. Selon la couleur choisie, la durabilité de l'intensité de celle-ci varie en fonction de l'exposition au soleil.*

*Certification UV standard 801 avec un facteur de protection UPF 80, qui garantie une protection de la peau face aux effets nocifs des rayons UV.*

*Résistante toile aux tâches - 100% recyclable.*

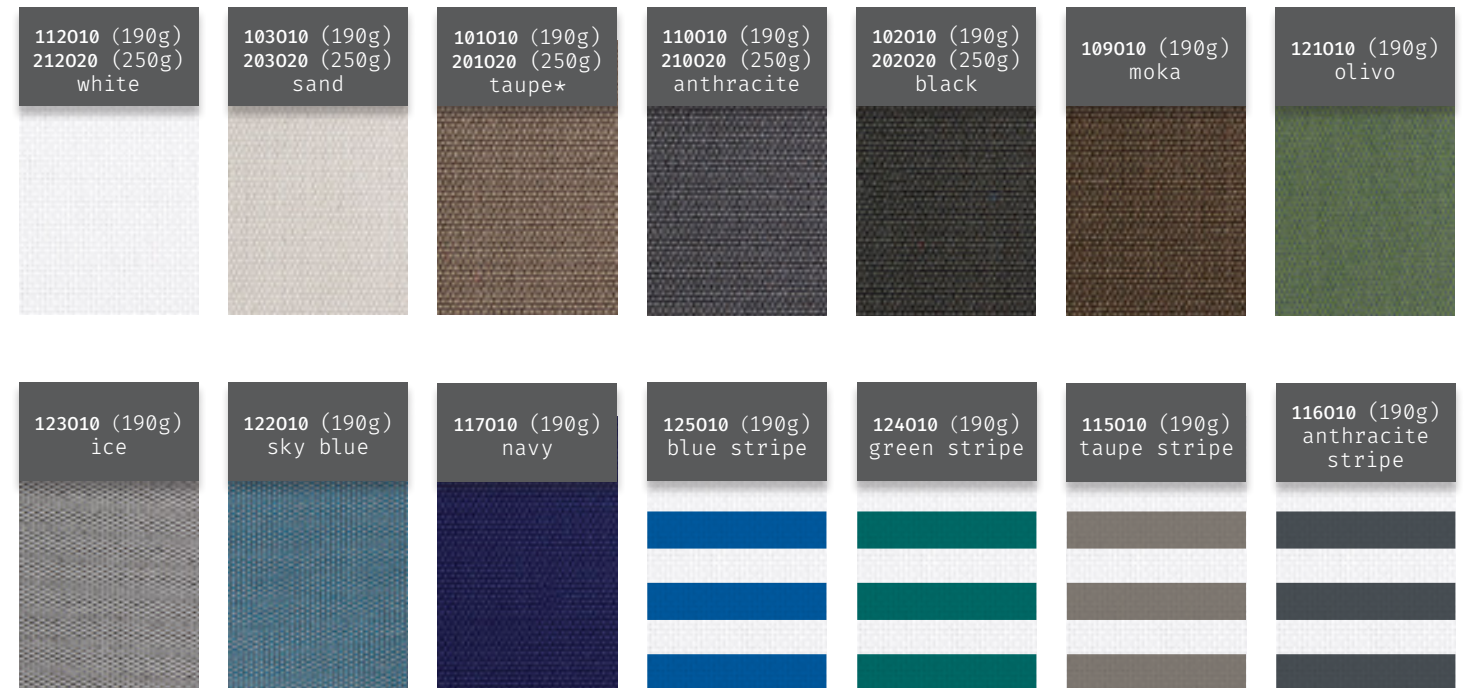

SOLUTION DYED - COLOUR FASTNESS: 7-8/8 - 100% RECYCLABLE

Disponemos de un tejido de poliéster 100% tintado en masa para pedidos con logotipo.  
 Temos um tecido 100% poliéster tingido em massa para pedidos com logotipo.  
 We have a 100% mass-dyed polyester fabric for orders with a logo.  
 Nous avons un tissu 100% polyester teint dans la masse pour les commandes avec logo.

\* Solidez 7-no recomendado para zonas de alta radiación solar. Solidez 7-Não recomendado para áreas de alta exposição solar. Color fastness rating 7-not recommended for areas with excessive sunlight exposure. Sa solidité est de 7-Déconseillé pour des zones à fort rayonnement solaire.



**SLAB** (hormigón/polipropileno - betão/polipropileno - concrete/polypropylene - béton/polypropylène)

Flexo  
Kit flexo  
Kit Cross  
Kit Cross Rio

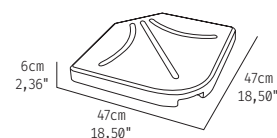

**BEC047BC03**  
white



**BEC047TP00**  
taupe



**BEC047NG02**  
anthracite

25kg-55,11lb  
100kg-220,46lb (4 U/)

- Peso de hormigón/polipropileno.
- *Peso em betão/polipropileno.*
- Concrete/polypropylene weight.
- *Poids en béton/polypropylène*

**KIT FLEVO** (hierro/hormigón/polipropileno - ferro/betão/polipropileno - iron/concrete/ polypropylene - fer/béton/polypropylène)

Flexo

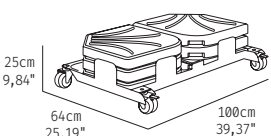

**BSH990BCK**  
white



**BSH990TPK**  
taupe



**BSH990ANK**  
black

150kg-330,69lb + 15kg-33,06lb (base)

- Base lateral de hierro cincado con ruedas y pesos de hormigón/polipropileno. \*El sistema de rotación del parasol Flexo no vale para esta base.
- *Base lateral em ferro zincado com rodas e pesos em betão/polipropileno. \*O sistema de rotação do guarda-sol Flexo não pode ser utilizado para esta base.*
- Zinc-plated iron side base with castors and concrete/polypropylene weights. \*The rotation system of the Flexo parasol is not suitable for this base.
- *Base latérale en fer zingué avec roulettes et poids en béton/polypropylène. \*Le système de rotation du parasol Flexo n'est pas adapté à cette base.*

**KIT CROSS RIO** (hierro/hormigón - ferro/betão - iron/concrete - fer/béton)

Rio

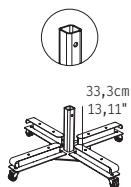
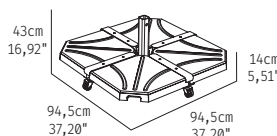

**BSRDBC6010K**  
CROSS RIO - white

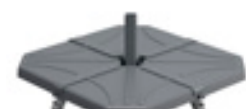

**BSRDAN6010K**  
CROSS RIO - anthracite

100kg-220,46lb + 10kg-22,04lb (base)  
tube ø57mm-2,24"

- Base de hierro cincado con ruedas y pesos de hormigón/polipropileno.
- *Base em ferro zincado com rodas e pesos em betão/polipropileno.*
- Zinc-plated iron base with castors and concrete/polypropylene weights.
- *Base en fer zingué avec roulettes et poids en béton/polypropylène.*

**KIT CROSS** (hierro/hormigón - ferro/betão - iron/concrete - fer/béton)

Formentera  
Eolo 3x3

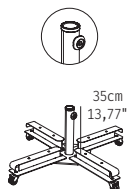
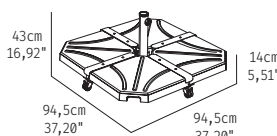

**BSRDBC6001K**  
CROSS - white



**BSRDAN6001K**  
CROSS - anthracite



**BSRDTP6001K**  
CROSS - taupe

100kg-220,46lb + 10kg-22,04lb (base)  
tube ø57mm-2,24"

- Base de hierro cincado con ruedas y pesos de hormigón/polipropileno.
- *Base em ferro zincado com rodas e pesos em betão/polipropileno.*
- Zinc-plated iron base with castors and concrete/polypropylene weights.
- *Base en fer zingué avec roulettes et poids en béton/polypropylène.*

**CUBE** (hormigón - betão - concrete - béton)

Eolo  
Formentera  
Vigo  
Java 3  
Madeira

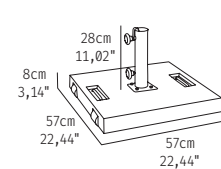

50kg-110,23lb  
tube ø57mm-2,24"



**BEC570BC00**  
white



**BEC570GR00**  
grey

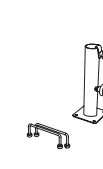

**52CUBEK**  
KIT 2 ASAS/PEGAS/HANDLES/POIGNÉES + INOX TUBE

- Base de hormigón con ruedas. Tubo y asas de acero galvanizado.
- *Base em betão com rodas. Tubo e pegas em aço galvanizado.*
- Concrete base with wheels. Galvanised steel tube and handles.
- *Base en béton avec roues. Tube et poignées en acier galvanisé.*

**FIX RIO** (hierro - ferro - iron - fer)

Rio

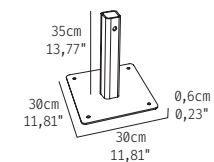

10kg-22,04lb  
tube ø60mm-2,36"



**BSC310BC63501**  
FIX RIO  
white



**BSC310AN63500**  
FIX RIO  
anthracite

- Base de hierro con cataforesis para atornillar a suelo.
- *Base em ferro com cataforesis para aparafusar ao chão.*
- Cataphoresis iron base for bolting to the floor.
- *Base en fer cataphorisée à fixer au sol.*

**FIX** (hierro - ferro - iron - fer)

Eolo  
Formentera  
Vigo  
Java 3  
Madeira

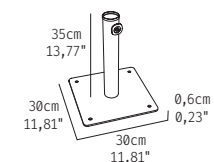

10kg-22,04lb  
tube ø60mm-2,36"



**BSC310GR6000**  
FIX  
grey



**BSC310BC6000**  
FIX  
white



**BSC310TP6000**  
FIX  
taupe



**BSC310AN6000**  
FIX  
anthracite

- Base de hierro con cataforesis para atornillar a suelo.
- *Base de ferro com cataforesis para aparafusar ao chão.*
- Cataphoresis iron base for bolting to the floor.
- *Base en fer cataphorisée à fixer au sol.*





## FAST CLICK RIO (inox)

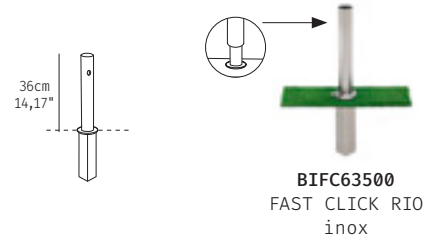

- Base de acero inoxidable para incrustar en el suelo.
- Base em aço inox para embutir no pavimento.
- Stainless steel base for embedding in the floor.
- Base en acier inoxydable pour scellage au sol.

Rio



## FAST CLICK (inox)



- Base de acero inoxidable para incrustar en el suelo.
- Base em aço inox para embutir no pavimento.
- Stainless steel base for embedding in the floor.
- Base en acier inoxydable pour scellage au sol.

**Tubo ø55:**  
Eolo  
Vigo  
Java 3  
Madeira

**Tubo ø60:**  
Formentera



## BOND 35 (hormigón/polipropileno - betão/polipropileno - concrete/polypropylene - béton/polypropylène)

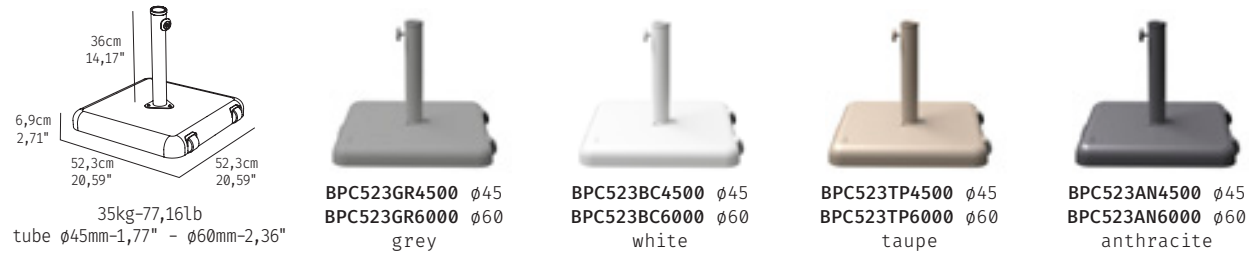

- Base de hormigón con carcasa de polipropileno, tubo de acero lacado con tratamiento antióxido (cataforesis), tornillería de acero inoxidable y ruedas.
- Base de betão com revestimento em polipropileno, tubo em aço lacado com tratamento anti-ferrugem (cataforese), parafusos em aço inoxidável e com rodas.
- Concrete base with polypropylene casing, anti-rust treated (cataphoresis) coated steel tubing, castors and stainless steel screws.
- Base en béton revêtit de polypropylène, tube en acier laqué avec traitement anti-rouille (cataphorèse), vis et roues en acier inoxydable.

**Tubo ø45:**  
Tenerife  
Ons  
Toscana  
Manila

**Tubo ø60:**  
Eolo  
Formentera  
Vigo  
Java 2x2  
Java 3  
Madeira  
Palma  
Menorca



## BOND 50 (hormigón/polipropileno - betão/polipropileno - concrete/polypropylene - béton/polypropylène)



- Base de hormigón con carcasa de polipropileno, tubo de acero lacado con tratamiento antióxido (cataforesis), tornillería de acero inoxidable y ruedas.
- Base de betão com revestimento em polipropileno, tubo em aço lacado com tratamento anti-ferrugem (cataforese), parafusos em aço inoxidável e com rodas.
- Concrete base with polypropylene casing, anti-rust treated (cataphoresis) coated steel tubing, castors and stainless steel screws.
- Base en béton revêtit de polypropylène, tube en acier laqué avec traitement anti-rouille (cataphorèse), vis et roues en acier inoxydable.

Eolo  
Formentera  
Vigo  
Java 2x2  
Java 3  
Madeira  
Palma  
Menorca

**NEW**



## LOOP (hierro - ferro - iron - fer)

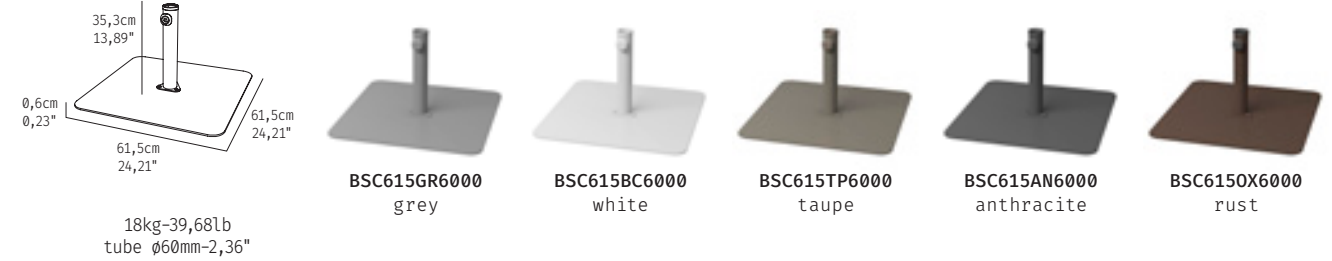

Eolo  
Formentera  
Vigo  
Java 2x2  
Java 3  
Madeira  
Palma  
Menorca

**NEW**

- Base de hierro con tratamiento antióxido (cataforesis). Tornillería en acero inoxidable.
- Base de ferro con tratamento anti-ferrugem (cataforese). Parafusos em aço inoxidável.
- Iron base with anti-rust treatment (cataphoresis). Stainless steel screws.
- Base en fer avec traitement anti-rouille (cataphorèse). Vis en acier inoxydable.

## CANTO (hierro - ferro - iron - fer)



**Tubo ø60:**  
Eolo  
Formentera  
Formentera Lateral  
Vigo  
Java 2x2  
Java 3  
Madeira  
Palma  
Menorca

**Tubo ø70:**  
Java 3x3

- Base de doble chapa de hierro. Cantoneras de acero inoxidable para separar la chapa del suelo. Ruedas con freno. Accesorio: Ruedas con freno.
- Base da placa dupla em ferro. Cantos em aço inoxidável para separar a placa do chão. Acessório: Rodas com freio.
- Double iron plate base. Stainless steel corners to separate the plate from the floor. Accessory: Wheels with brake.
- Double base en fer. Coins en acier inoxydable pour séparer la plaque du sol. Accessoire: Roues avec frein.

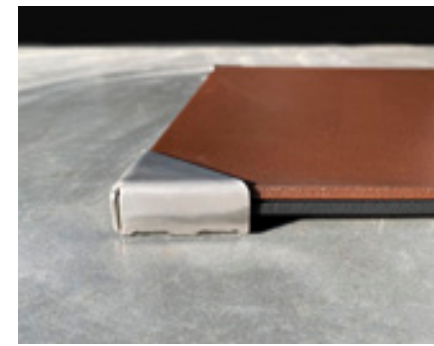

MO-SIE41K (kit 4 U)  
Rueda con freno - roda com travão - wheels with brake - roue avec frein.

## FIT (hierro - ferro - iron - fer)

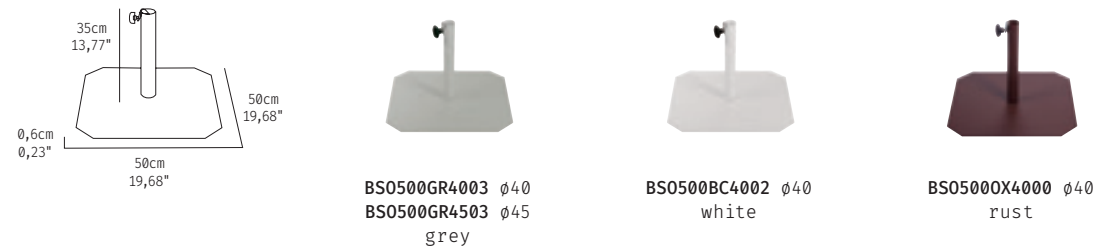

**Tubo ø40:**  
Ons  
New Toscana  
Manila

**Tubo ø45:**  
Tenerife

- Base octogonal de hierro.
- Base de ferro octogonal.
- Octagonal iron base.
- Base octogonale en fer.



## POLYPROPYLENE

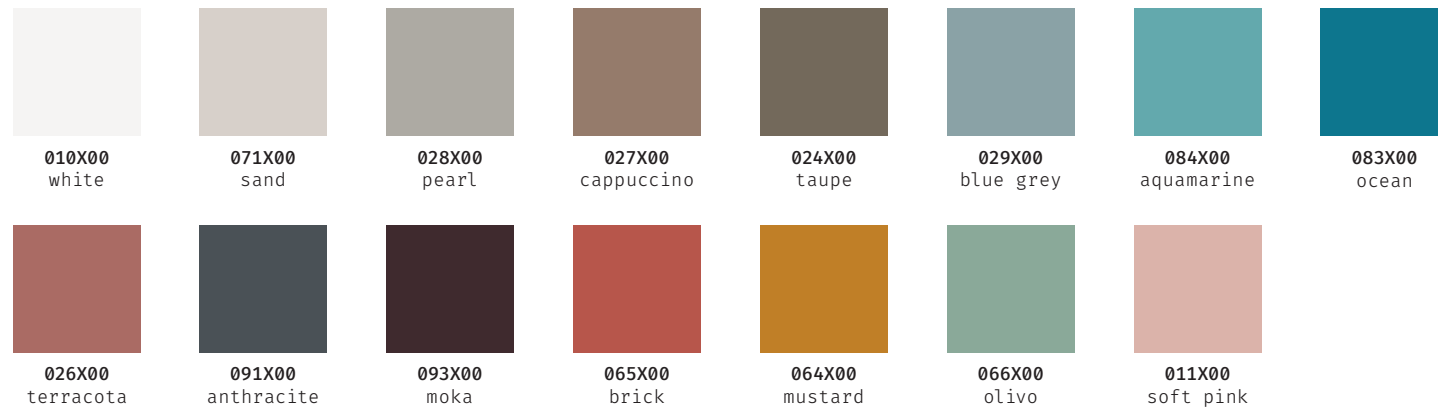

## COMPACT

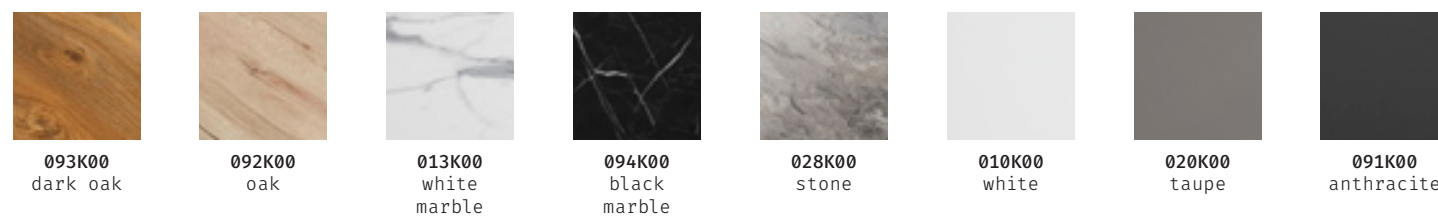

## METAL

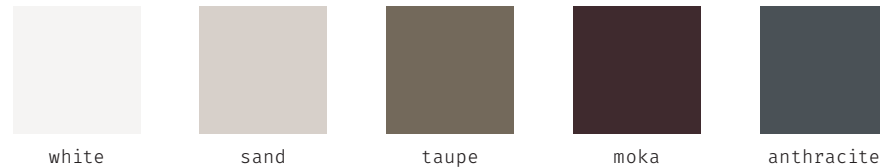

## OLEFIN



## SUNBRELLA

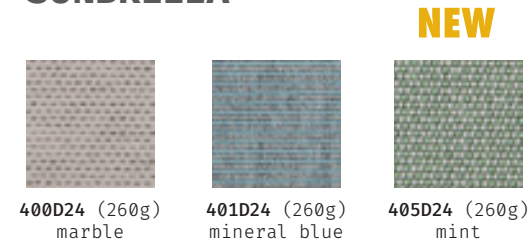

## POLYESTER 100% - LOGO



## PHIFERTEX®

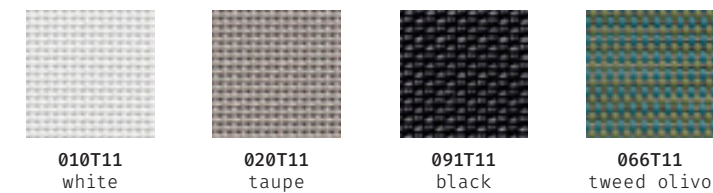

## AQUA



## WOOD (BAKE)

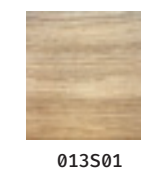

## PAD

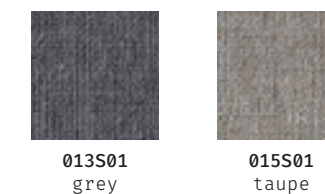

## NAUTIC



## IBIZA



## NEW NAUTIC (IBIZA & NANA)

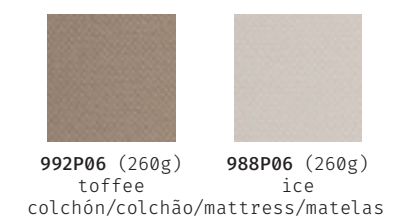





Contact us:

SPAIN

info@ezpeleta.com  
tel. +34 986 293 922

PORTUGAL

ezpeleta.portugal@ezpeleta.com  
tel. +351 251 79 62 55

FRANCE

france@ezpeleta.com  
tel. +34 986 293 922

MEXICO

ezpeleta.mexico@ezpeleta.com  
tel. +52 55 5520 2919  
tel. +52 55 5520 5909

EXPORT (other countries)

export@ezpeleta.com  
tel. +34 986 293 922

Ezpeleta se reserva el derecho a realizar modificaciones técnicas en los productos de este catálogo. / A Ezpeleta reserva-se o direito de realizar qualquer alteração técnica nos produtos descritos neste catálogo. / Ezpeleta reserves the right to change the technical characteristics and specifications of the product in this catalog. / Ezpeleta se réserve le droit de réaliser des modifications techniques sur les produits décrits sur ce catalogue.

Todas las medidas y colores indicados en este catálogo son aproximados. / Todas as medidas e cores indicadas neste catálogo são aproximadas. / All dimensions and colours indicated in this catalogue are approximate. / Toutes les dimensions et couleurs indiquées dans ce catalogue sont approximées.

EMPRESA ASOCIADA 



# ezpeleta<sup>e</sup>

Follow us / Síguenos:



EZPELETA GROUP  
SINCE 1935

